

RADIO'S LIVEST MAGAZINE



April
25 Cents
Canada 30c

Radio-Craft

HUGO GERNSBACK Editor

*Here
are the
New Tubes
See page 586*



**Beginning —
A Radio
Beginners'
Department**

**Filamentless Tubes—Useful V. T. Voltmeters—Tube Reference Index
How to Make a New Tube Tester—Constructing a Simple Pentode Set**



McMURDO~SILVER

THE MASTERPIECE DOES MORE THAN MERELY TUNE 'ROUND THE WORLD

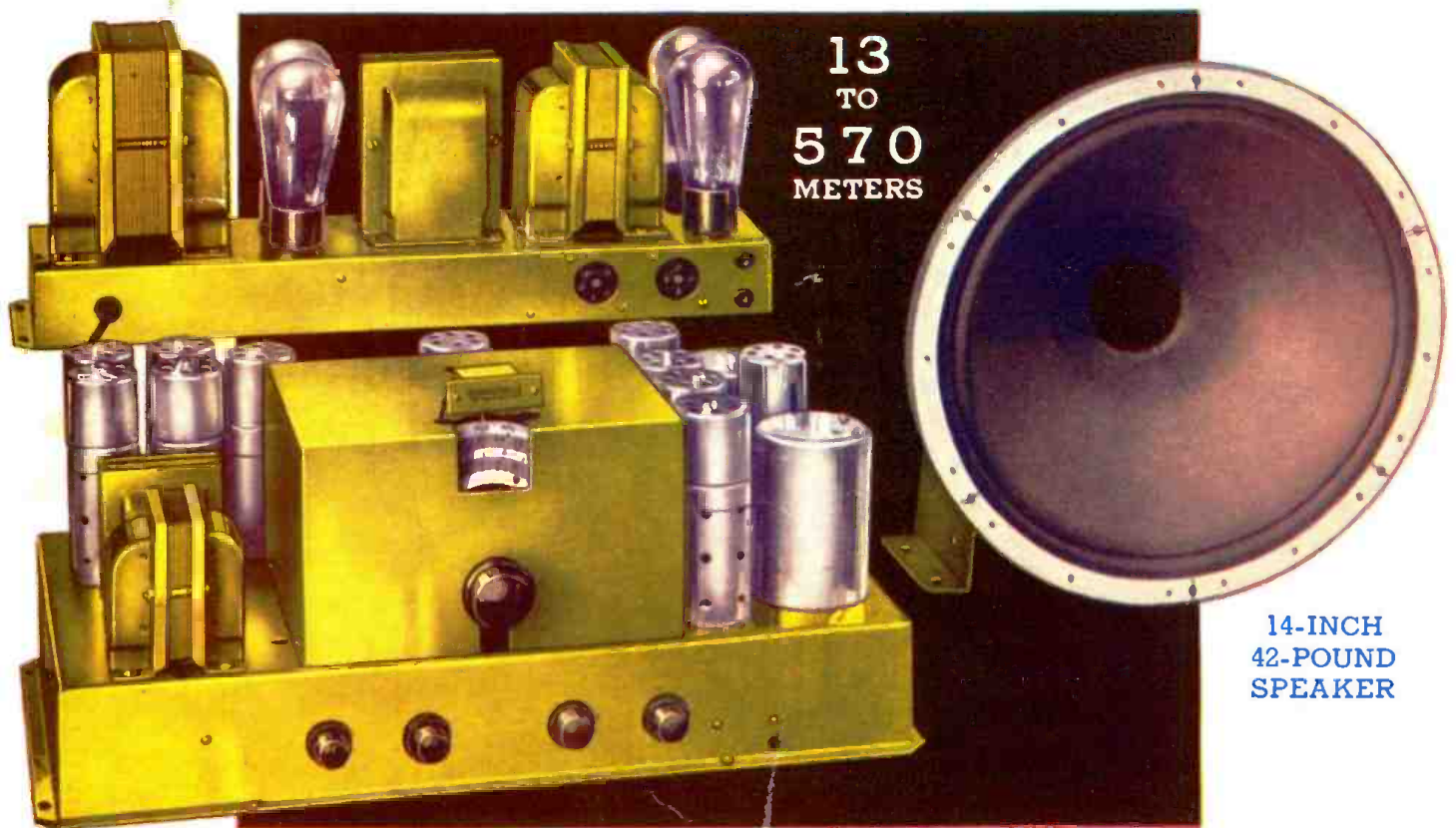

14-INCH
42-POUND
SPEAKER

OF COURSE The Masterpiece tunes 'round the world. But there are really profound reasons for the emphatic preference true DXers have accorded this ingenious product of forward thought. First, is the interesting FACT that The Masterpiece is *actually* laboratory-built . . . *actually* a precision instrument . . . *actually* all that is claimed for it! Then, there are its several sensational new features. For instance, a ratio

of signal to noise so high that thoroughly enjoyable foreign reception is obtained . . . *even at ten watts undistorted output!* And a direct-reading dial so accurately calibrated from 13 to 570 meters that *any* short wave or broadcast station is easily and *instantly* found! Also, a new method of wave band change that positively will not become noisy or inefficient through use. In addition . . . automatic volume control . . . automatic and manual tone control . . . meter tuning . . . silent tuning between stations . . . built-in audio beat oscillator . . . a 42-pound, 14-inch speaker delivering four times the output of any other . . . and, each receiver individually logged on three foreign stations and curve-plotted by McMURDO Silver, personally. Six cents in stamps and the coupon from this announcement will bring full technical details of The Masterpiece . . . the only radio offered with a guarantee of ten days' free trial in your home and your money promptly refunded if it isn't absolutely satisfactory to you in every way.

McMURDO SILVER INC.
1132 W. Austin Ave., Chicago.
Six cents in stamps enclosed. Send me your book giving full technical details and performance facts on The Masterpiece.

Name

Street

Town..... State.....

McMURDO SILVER INC.
1132 WEST AUSTIN AVENUE CHICAGO

LEARN RADIO IN 10 WEEKS!

PAY FOR YOUR TRAINING AFTER YOU GRADUATE

I am making an offer that no other school has dared to do. I'll take you here in my shops and give you this training and you pay your tuition after you have graduated. Two months after you complete my course you make your first payment, and then you have ten months to complete your payments. There are no strings to this offer. I know a lot of honest fellows haven't got a lot of money these days, but still want to prepare themselves for a real job so they won't have to worry about hard times or lay offs.

I've got enough confidence in these fellows and in my training to give them the training they need and pay me back after they have their training.

If you who read this advertisement are really interested in your future here is the chance of a life time. Mail the coupon today and I'll give you all the facts.



A scene in the big, busy Radio Shops at Coyne. Here you see fellows working on real Radios—not reading about them from books or lessons. This is THE way to prepare for the big-money field of Radio!

TELEVISION *and* TALKING PICTURES

Television is already here! Soon there'll be a demand for THOUSANDS of TELEVISION EXPERTS! The man who learns Television now can have a great future in this great new field. Get in on the ground-floor of this amazing new Radio development! Come to COYNE and learn Television on the very latest, newest Television equipment. Talking Picture and Public Address Systems offer opportunities to the Trained Radio Man. Here is a great new Radio field just beginning to grow! Prepare NOW for these wonderful opportunities! Learn Radio Sound Work at Coyne on actual Talking Picture and Sound Reproduction equipment.

PREPARE NOW and be ready for Radio's many opportunities

Forget pay-cuts—lay-offs—unemployment! Don't be tied down to an untrained man's future. You NEED TRAINING IN A FAST-GROWING MONEY-MAKING TRADE. Here's your chance of a lifetime to get it! Hundreds of opportunities now open in Radio. My sensational offer, explained below, makes it possible for you to START AT ONCE!

The right way to learn Radio is the Coyne way—not by books, but by actual, practical work on actual Radio, Television and Sound equipment. Here at Coyne you'll service and operate scores of modern Radio receivers, huge Broadcasting equipment, late type Television apparatus, Talking Picture machines, Code transmitters and receivers, etc. In 10 weeks you can step into a REAL JOB, leading to a salary of \$50 a week and UP!

ALL PRACTICAL WORK At COYNE in Chicago

ALL ACTUAL, PRACTICAL WORK. You build radio sets, install and service them. You actually operate great Broadcasting equipment. You construct Television Receiving Sets and actually transmit your own Television programs over our modern Television equipment. You work on real Talking Picture

machines and Sound equipment. You learn Wireless Operating on actual Code Practice apparatus. We don't waste time on useless theory. We give you the practical training you'll need—in 10 short, pleasant weeks.

MANY EARN WHILE LEARNING

You get Free Employment Service for Life. And don't let lack of money stop you. Many of our students make all or a good part of their living expenses while going to school and if you should need this help just write to me. Coyne is 33 years old. Coyne Training is tested—proven beyond all doubt. You can find out everything absolutely free. Just mail coupon for my big free book!

H. C. LEWIS, Pres. RADIO DIVISION Founded 1899
COYNE ELECTRICAL SCHOOL
500 S. Paulina St., Dept. 43-8H, Chicago, Ill.

Mail Coupon Today for All the Facts

H. C. LEWIS, President
Radio Division, Coyne Electrical School
500 S. Paulina St., Dept. 43-8H, Chicago, Ill.

Dear Mr. Lewis: Send me your big FREE Book; details of your FREE Employment Service; and tell me all about your special offer of allowing me to pay for training on easy monthly terms after graduation.

Name.....
Address.....
City..... State.....



HUGO GERNSBACK, Editor-in-Chief

LOUIS MARTIN
Associate Editor

R. D. WASHBURNE
Technical Editor

CONTENTS OF THE APRIL, 1933, ISSUE

VOLUME IV

NUMBER 10

EDITORIAL:

The Radio Beginner.....Hugo Gernsback 585

NEW DEVELOPMENTS IN RADIO:

Here Are the New Tubes!.....Louis Martin 586

The Radiolight "Talking Beam".....Elman B. Myers 592

The Latest Radio Equipment..... 594

SERVICE MEN'S DEPARTMENT:

How To Make A Modern Bench-Type Test Panel F. L. Sprayberry 596

Activities of the Official Radio Service Men's Association..... 601

New Analyzers For Old H. G. Cisin 602

Constructing A Simple Modern Tube TesterMilton Reiner 606

Making Money With Amplifiers Hubert L. Shortt and Frank Lester 608

Operating Notes.A. R. Quackenbush 610

RADIO SERVICE DATA SHEETS:

No. 87 Crosley Roamio Automotive T.R.F. Receiver Models 90, 91 and 92..... 612

No. 88 Crosley Roamio Automotive Superheterodynes Models 95 and 96 613

TECHNICAL RADIO TOPICS:

How To Build the Postal "Universal" Kit Set..... N. M. Haynes 589

More Information on the Trautonium..... Fritz Noack 590

How To Build A 110-Volt Transformerless Receiver Leon J. Littmann 600

Now! Build the Megadyne "N" Receiver Hugo Gernsback 604

Readers' Department..... 614

Radio-Craft's Information Bureau..... 615

IN OUR NEXT FEW ISSUES:

HOW TO MAKE A MIDGET ANALYZER. The trend toward smaller and smaller devices, so evident in the design of late-model radio sets, is reflected in the design of an exceptionally compact analyzer which will be described in complete detail in a construction article. This test unit will satisfy most every Service Man, since the instrument weighs but very little and takes up a minimum amount of space in the old duffle-bag.

BROADCAST STATION CALLS. Many Service Men, and experimenters, too, rely upon the accuracy of broadcast station frequencies and wavelengths to calibrate receivers and test equipment. To the end that this material is particularly useful to the technician, we will print a compendium of this data, and station call-letters, for every broadcast station now licensed by the Federal Radio Commission.

A WUNDERLICH-TUBE SERVICE OSCILLATOR. Construction details of a service oscillator of modern design. Through the use of the Wunderlich twin-grid tube, an efficient test unit is obtained.

RADIO-CRAFT is published monthly, on the fifth of the month preceding that of date; its subscription price is \$2.50 per year. (In Canada and foreign countries, \$3.00 a year to cover additional postage.) Entered at the post office at Mt. Morris, Ill., as second-class matter under the act of March 3, 1879. Trademark and copyright by permission of Gernsback Publications, Inc., 98 Park Place, N. Y. C. Text and illustrations of this magazine are copyright and must not be reproduced without permission of the copyright owners. We are also agents for WONDER STORIES and WONDER STORIES QUARTERLY. Subscription to these magazines may be taken in combination with RADIO-CRAFT at reduced Club rates. Write for information. Copyright 1933. GERNSBACK PUBLICATIONS, INC.

HUGO GERNSBACK, President
S. GERNSBACK, Treasurer

J. M. HERZBERG, Vice-President
I. S. MANHEIMER, Secretary

Published by TECHNI-CRAFT PUBLISHING CORPORATION. Publication office: 404 N. Wesley Ave., Mount Morris, Illinois. Editorial and Advertising Office: 96-98 Park Place, New York City. Chicago Advertising Office: 737 North Michigan Avenue, Chicago, Ill. Western Advertising Office: 220 No. Catalina St., Los Angeles, Calif. L. F. McClure, Chicago Advertising Representative. Loyd B. Chappell, Western Advertising Representative.

London Agent: Hachette & Cie., 3 La Belle Sauvage, Ludgate Hill, E.C. 4
Paris Agent: Hachette & Cie.,
111 Rue Reaumur
Australian Agent: McGill's Agency
179 Elizabeth St., Melbourne

I alone  Guarantee

Consistent ~ day in and day out
WORLD-WIDE RECEPTION

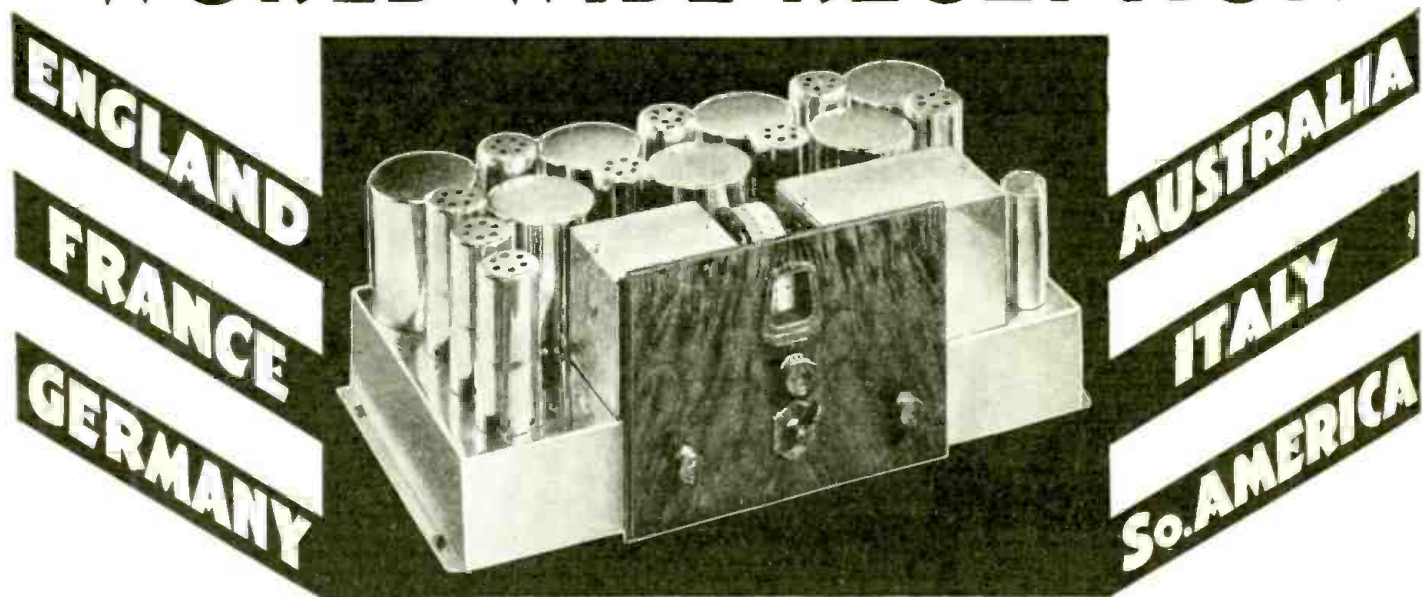

The **SCOTT** 15-550 METER ALL-WAVE *Deluxe* **RADIO**

There are no "ifs" "buts" "under favorable conditions" or other equivocations in the SCOTT guarantee. It says, simply and clearly, that at the set I build for you will receive foreign broadcasts from stations as far as 10,000 miles away, with loud-speaker volume, consistently, at all seasons of the year.

In addition, every part of the set (except tubes) is guaranteed against breakdown or service failure for a five-year period instead of the ordinary 90-day term.

Beside bringing you dependable direct short wave reception of advertising-free foreign programs, this remarkable radio will receive literally everything upon the North American continent on the regular broadcast band. Its rich, natural tone is a revelation—giving you reproduction of voice and music so exact that variation from actuality can be measured only with super-delicate instruments, being undetectable by the human ear.

Such performance comes only from exacting laboratory construction, constantly checked and tested by extensive scientific equipment. Backing it is the SCOTT experience of more than eight years in building world's-record-breaking radio receivers.

Claims are easily made—a *Guarantee* is something different! Which do you want—the *hope* that your receiver can deliver performance, or *positive assurance* that it will?

Then send at once for all particulars about the radio known as "The World's Finest Receiver."

E. H. SCOTT RADIO LABORATORIES, INC.
 4450 Ravenswood Ave., Dept. C-43, Chicago, Ill.

Winning Praise Galore

Here are just a few extracts from hundreds of letters of praise on file in my laboratories, which may be inspected by anyone. "Your claims of 10 kilocycle selectivity 100% correct," SGP, Ala. . . "Regarding tone, nothing could be finer," FW, Calif. . . "Stations all the way from Berlin to Tokio and Australia," JBT, Conn. . . "VK3ME, Melbourne, 10,500 miles from here, received each time on the air," CGB, Conn. . . "European stations as much 'at my finger tips' as ordinary locals," TPB, D. C. . . "Listen to Madrid every night while eating dinner," WHB, Ind. . . "Seven year old son regularly receiving RW59—VK2ME—VK3ME—

Vindicating All Claims

EAQ—DJA—2RO—G5SW—Pon-toise and many more," CK, Maine. . . "Madrid on short waves (direct) just as good as WAAB rebroadcasts it," JJO'C, Mass. . . "After so much untruthful advertising it is very gratifying to get a radio set that really does what is claimed for it," CEMcK, Mo. . . "First station tuned in was VK2ME Australia. Boy, what a set!" LGD, N. J. . . "Triumphant vindication of all claims you make for it; performance convinces me you have been extremely conservative in outlining its potentialities," RD, N. Y. . . "Simply too wonderful for words," HCVS, So Africa. . . "Performance really wonderful," MC, Paris, France.

These New Brochures Tell the
"SCOTT SECRET"

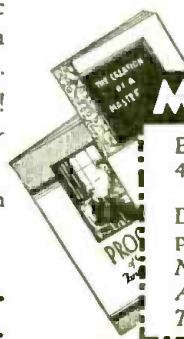

MAIL THIS COUPON NOW

E. H. SCOTT RADIO LABORATORIES, INC.
 4450 Ravenswood Ave., Dept. C-43, Chicago, Ill.
 Send me complete details about the SCOTT ALL-WAVE DeLuxe RADIO, explaining why this set *Guarantees* the performance that others only claim.

Name

Address

Town

State

Radio-Craft

FREE

BOOKLET SERVICE

5. CLAROSTAT CONTROL HANDBOOK. A large 32-page book containing detailed specifications of volume controls, attenuators, constant-impedance controls, phonograph pickup faders, tone controls, line ballasts, rheostats, potentiometers and fixed resistors of various kinds, together with valuable circuit-design data. Contains many diagrams and charts, and a guide of replacement volume and tone controls for many commercial receivers. *Clarostat Manufacturing Company, Inc.*

6. MEASURING RESISTANCE BY THE DEFLECTION METHOD. The conventional method for the measurement of resistance involves the use of the Wheatstone bridge, a costly piece of apparatus. However, there are other methods which provide a fair degree of accuracy, enough for all practical purposes. The least expensive is the deflection method, which makes use of popularly priced milliammeters and fixed resistors. This bulletin describes the method completely, and should be very useful to Service Men and experimenters with limited meter equipment. *Shallcross Manufacturing Company.*

11. SUPREME INSTRUMENTS. Contains lengthy descriptions of the Supreme service instruments, including the AAA1 Diagonometer, which is five instruments in one, the model 90 analyzer, the model 40 tube tester and the models 60 and 70 oscillators. Interesting to the Service Man because it tells how his work is facilitated by ingeniously-designed test equipment that indicates the condition of an entire set in a few minutes. New test apparatus to take care of the new tubes is also described. *Supreme Instrument Corporation.*

19. A BAPTISM OF FIRE. Centralab fixed resistors are made by forcing a carefully calibrated resistance material through a plastic ceramic material, and then baking both under terrific heat. This booklet describes the manufacturing process in detail, and lists the advantages claimed for fixed resistors of this type. It is interestingly written and illustrated, and makes good reading. *Central Radio Laboratories, Inc.*

21. READRITE RADIO INSTRUMENTS. This sixteen-page pamphlet contains some valuable hints on the testing of electrolytic condensers, as well as descriptions of the full line of popular-priced Readrite instruments. Worth having. *Readrite Meter Works.*

22. HOW TO TEST PENTODES. This is a reprint of an article of the same name that appeared in the September, 1931, number of RADIO-CRAFT, accompanied by descriptive matter on the adapters specified for the purpose. If you missed the original article study the reprint; it contains much useful data for owners of testers or analyzers not already equipped to test pentodes. *Alden Manufacturing Company.*

28. HAMMARLUND PRECISION PRODUCTS. Midget variable condensers and their numerous applications in short-wave and broadcast receivers are discussed in a folder accompanying the complete catalog of Hammarlund variable condensers and coils. Some excellent circuit kinks are given. The catalog contains dimensional drawings of the popular Hammarlund midgets which may be of assistance to constructors designing small receivers. *Hammarlund Manufacturing Company, Inc.*

55. PHILCO PARTS CATALOG. This catalog will undoubtedly be of great help to all radio Service Men because it contains the only official, complete list of the more common replacement parts used in every Philco receiver from the very beginning of the company to the present time. The manufacturers are anxious to cooperate with Service Men and offer this catalog to all who want it. *Philco Radio & Television Corp.*

64. SYLVANIA RADIO TUBES. So many new tubes have appeared during the past several months that tube charts printed as recently as the Fall are incomplete and therefore of little value for reference purposes. Readers desiring new and complete charts for their shop wall will find the new Sylvania chart very desirable. It measures 11 by 17 inches when unfolded and shows bottom views of the tube bases in addition to full average characteristics of old tubes dating back to the 199 and 200A and all the new tubes including the latest 6.3 and 2.5 volt types. Special mention is made of the 56, 57, 58, 46 and 82 tubes; complete data are also given on the 38, 41, 69, 42 and 44. *Hygrade Sylvania Corporation.*

66. WHOLESALE RADIO SERVICE CATALOG. The 1933 Radio Catalog of the Wholesale Radio Service Company is the kind of catalog the radio Service Man and experimenter will carry around with him all the time in his back pocket. Measuring 7 by 10 1/4 inches and containing 144 pages, it is one of the most complete catalogs we have ever seen. It includes everything from soldering lugs to all-wave combinations, and is of particular value to the Service Man because of its handy lists of replacement parts for standard receivers. *Wholesale Radio Service Company, Inc.*

READERS' BUREAU

On this page are listed manufacturers' catalogs and booklets, chosen because they are of interest to readers of RADIO-CRAFT. You can obtain copies FREE by using the coupon below.

76. THE COAST-TO-COAST "BROADCAST." The "Broadcast" is the Fall 1932 edition of a 100-page mail order catalog that is a veritable encyclopedia. Its listings are very varied, and run from soldering lugs to complete 100-watt public address amplifiers. Every article is well illustrated and described for the benefit of radio dealers and Service Men, for whom the volume is specifically intended.

A large amount of space is also given to replacement power transformers, condensers and resistors for ordinary service work. This catalog is well prepared and is worth saving. *Coast-to-Coast Radio Corporation.*

80. FLECHTHEIM CONDENSERS. A wide variety of fixed condensers, ranging from tiny midgets, the size of postage stamps, to heavy transmitting units a foot high, are described and illustrated in the latest Flechtheim catalog. This is very useful for reference in design and service work, as it gives the mechanical dimensions and electrical characteristics of all models in minute detail. *A. M. Flechtheim & Co.*

81. I. R. C. RESISTOR CATALOG. This sixteen-page catalog describes a very complete line of fixed resistors for radio purposes. It includes full performance characteristics, so that a Service Man or an experimenter with a particular requirement in mind can select exactly the right unit for his purpose. A section in the back contains valuable data on the conversion of milliammeters into ohmmeters and voltmeters, and on the extension of voltmeter and ammeter ranges. This catalog is well worth saving. *International Resistance Company.*

86. YANLEY AND ELKON CATALOGS. The Yanley catalog is valuable for the Service Man because it lists numerous rheostats, potentiometers, volume controls, replacement controls and resistances for service work. Detailed dimension drawings are included; this feature will be appreciated by every Service Man who has been called on to install replacement units in cramped receivers. Two pages of volume control replacement information are included, along with fourteen diagrams showing different circuit positions for such controls.

The Elkton catalog is devoted exclusively to dry electrolytic high voltage condensers for filter and bypass purposes. It also includes valuable replacement data on commercial receivers. *P. R. Mallory & Co.*

89. MICROPHONES. A complete line of microphones and accessories for amateur, public address and broadcast station use is described and illustrated in a handy four-page pamphlet. The "mikes" range from small hand units to large condenser models containing two stages of amplification. *Sound Engineering Corporation.*

93. DUBILIER CONDENSERS. The 1933 catalog of Dubilier condensers is a large 16-page booklet describing fixed condensers for every conceivable application. These range from little mica units for receiving circuits to man-high assemblies for transmitting work. A useful catalog to all radio men. *Dubilier Condenser Corporation.*

94. ELECTRAD PRODUCTS. The newest and latest catalog of Electrad products contains twelve pages and lists many types of fixed and

variable resistors and five different kinds of amplifiers for public address purposes. The popular Truvolt resistors have been improved by the addition of insulating shields and heat radiating covers, and a number of new sizes have been added to the line. The catalog also contains some valuable data on the application of resistors to radio receivers, transmitters, amplifiers and sound systems, and suggestions on how to compute the value of resistors. A handy and useful catalog. *Electrad, Inc.*

95. CARDWELL CONDENSERS. This is a condensed four-page catalog of the well known Cardwell "Midway" variable condensers for transmitting and receiving. These are small but not "midget" size instruments designed for purposes where extremely light weight and reduction of bulk are desirable. Complete and detailed specifications are included for the assistance of constructors. *Allan D. Cardwell Mfg. Corp.*

96. TOBE FILTERIZER AND CONDENSERS. The Tobe Deutschmann company is now catering to the Service Man with an extensive line of filter, by-pass and line condensers and radio noise eliminators. Their latest catalog, describing the complete line, has just come off the press. A full page is given to the new "Filterizer" noise eliminating antenna system, an item of particular interest to Service Men because of the money-making opportunities it offers. *Tobe Deutschmann Corporation.*

97. ARCO TUBE BULLETIN. A descriptive folder giving full technical characteristics on the complete line of Arco radio receiving and transmitting tubes, photo-electric cells, television lamps, hot and cold cathode tubes, cathode ray tubes, rectifiers and charger bulbs. This can be posted for easy reference. *Arco Tube Company.*

98. HOW TO USE NOISE REDUCING ANTENNA SYSTEM ON BROADCAST WAVES AND SHORT WAVES is the title of the latest booklet on this important subject. In addition to covering the theory, the practical application of the various noise-reducing systems available for broadcast and short wave use, is described also.

A section of the bulletin is devoted to the interest of the Service Man and dealer. It tells how to set up demonstration installations which show the comparison of the new systems and the older systems by simply throwing a single pole, double throw switch and makes important suggestions for increasing sales and service profits through the sale of these devices to new receiver buyers as well as the person who already owns a set. *Lynch Mfg. Co.*

99. AMPERITE CHART. Service Men will find this chart very valuable, as it shows the correct Amperite line voltage regulator to use with any of several hundred different broadcast receivers. An accompanying pamphlet explains how overloaded condensers and resistors may be the cause of crackling noises and poor reception. *Amperite Corporation.*

RADIO-CRAFT 5-99

Readers Bureau
96-98 Park Place, New York, N. Y.

Please send me free of charge the following booklets indicated by numbers in the published list above:

No.
Name
Address
City State.....

(Please check the following)

I am
(1) Service Man (2) Experimenter
(3) Dealer (4) Jobber
(5) Radio Engineer
(6) Licensed Amateur
(7) Professional or Amateur Set
Builder

This coupon will not be honored unless you check off your classification above.

I Will Show You Too

How to Start a Spare Time or Full Time Radio Business of Your Own

Without Capital



J. E. SMITH, President
National Radio Institute
The man who has directed the Home-Study Training of more men for the Radio industry than any other man in America.

Here are a few examples of the kind of money I train "my boys" to make

Made \$2000 in the Radio Business



"Soon after I began to do Radio work in full time I started a store known as the 'Chapin Radio Shop' and handled a large amount of repair work. I have made close to \$2000 and if I couldn't get the Course over, \$5000 couldn't take from me my N.R.I. data books and helps. I can safely say that the N.R.I. has kept me out of the throng of unemployed this year." **CARL H. CHAPIN**, Box 222, Edmeston, N. Y.

\$1500 in spare time

"After finishing nine lessons I started doing some repair jobs and have since made \$1500 in spare time. I have found that time of depression means more Radios to repair, because people have their old sets fixed. Instead of buying new ones. Anyone interested in making more money, in spare time, will not go wrong by taking the N.R.I. training." **J. B. MILBY**, Box 95, Ulea, Michigan.



Averages \$80 per month in spare time



"I am getting along well in my Radio work, always being kept very busy. Since enrolling I have averaged around \$80 a month, working on Radios just part time, since I am still holding down my regular job in a shoe factory. I highly recommend the N.R.I. to every man interested in Radio work." **JOHN B. MORISSETTE**, 733 Somerville St., Manchester, N. H.

My Free book gives you many more letters of N. R. I. men who made good in spare time or full time businesses of their own

The world-wide use of Radio sets for home entertainment has made many opportunities for you to have a spare time or full time Radio business of your own. I give you instructions early in your Course for doing 28 Radio jobs common in every neighborhood. Many N.R.I. men make \$5, \$10, \$15 a week extra in spare time almost at once. I show you how to install and service all types of receiving sets. I give you Radio equipment and instructions for conducting experiments, for building circuits, and testing equipment, and for making tests that will give you broad, practical Radio experience. Clip the coupon below and get my free 64-page book, "Rich Rewards in Radio"—it gives you a full story of the success of N.R.I. students and graduates, and tells how to start a spare time or full time Radio business of your own without capital.

Many N. R. I. men make \$5, \$10, \$15 a week extra servicing sets in spare time

Many of the more than sixteen million sets now in use are only 25% to 40% efficient. I will show you how to cash in on this condition. I will show you the plans and ideas that have enabled many others to make \$5, \$10, \$15 a week in spare time while learning. **Ford R. Leary**, 1633 Davison Road, Flint, Michigan, wrote: "My part time earnings while taking the N.R.I. Course were \$65."

Get ready Now for a Radio business of your own and for Jobs like these

Broadcasting stations use engineers, operators, station managers, and pay up to \$5,000 a year. Radio manufacturers use testers, inspectors, foremen, engineers, service men, and buyers and pay up to \$6,000 a year. Radio dealers and jobbers employ hundreds of service men, salesmen, managers, and pay up to \$100 a week. Talking movies pay as much as \$75 to \$200 a week to the right men. My book tells you of the opportunities in Radio, Talking Movies, Set Servicing, Aircraft Radio, Television, Police Radio, Short Wave, and other fields. Get it.

I Will Train You at Home in Your Spare Time

Hold your job until you're ready for another. Give me only part of your spare time. You do not need a high school or college education. Hundreds with only a common school education have won bigger pay through N.R.I. **J. A. Vaughn** jumped from \$35 to \$100 a week. **J. E. McLaurine** increased his earnings 100%. The National Radio Institute is the Pioneer and World's largest organization devoted exclusively to training men and young men by Home Study for good jobs in the Radio industry.

You Must Be Satisfied

I will give you an agreement to refund every penny of your money if you are not satisfied with my Lessons and Instruction Service when you complete my Course. And I'll not only give you thorough training in Radio principles, practical experience in building and servicing sets, but also Advanced Training in any one of five leading branches of Radio opportunities.

My 64-Page Book Gives the Facts

Clip and mail the coupon now for "Rich Rewards in Radio." It's free to residents of the U. S. and Canada over 15 years old. It points out the money-making opportunities the growth of Radio has made for you. It tells of the opportunities for a spare time or full time Radio business of your own, the special training I give you that has made hundreds of other men more successful; and also explains the many fine jobs for which my Course trains you. Send the coupon to me today. You won't be obligated in the least.

Get my new book It points out what Radio Offers You



J. E. Smith, Pres.
National Radio Institute,
Dept. 3DX,
Washington, D. C.

SPECIAL FREE OFFER

Act now and receive in addition to my big free book, "Rich Rewards in Radio," this Service Manual on D.C., A.C., and Battery operated sets. Only my students could have this book in the past. Now readers of this magazine who mail the coupon will receive it free. Overcoming hum, noises of all kinds, fading signals, broad tuning, howls and oscillations, poor distance reception, distorted or muffled signals, poor Audio and Radio and Radio frequency amplification and other vital information is contained in it. Get a free copy by mailing the coupon below.



SOME OF THE JOBS N.R.I. TRAINS MEN FOR

- Broadcast Engineer
- Maintenance Man in Broadcasting Station
- Installation Engineer of Broadcast Apparatus
- Operator in Broadcast Station
- Aircraft Radio Operator
- Operator of Airway Beacons
- Service Man on Sound Picture Apparatus
- Operator of Sound Picture Apparatus
- Aircraft Radio Maintenance and Repairman
- Recording Operator
- Service Man on Television Sets
- Ship Operator
- Service Man on Public Address Systems
- Installation Engineer on Public Address Systems
- Sales Manager for Retail Stores
- Service Manager for Retail Stores
- Auto Radio Installation and Serviceman
- Television Broadcast Operator
- Set Servicing Expert
- Inspector and Tester in Factory
- Factory Service and Repairman
- Operator in Commercial Station

THIS COUPON IS GOOD FOR ONE FREE COPY OF MY NEW BOOK

mail it TODAY

J. E. Smith, President,
National Radio Institute, Dept. 3DX
Washington, D. C.

Dear Mr. Smith: I want to take advantage of your Special Offer. Send me your Service Manual "Trouble Shooting in D.C., A.C. & Battery sets" and your book "Rich Rewards in Radio," which points out the opportunities for spare time and full time jobs in Radio. I understand this request does not obligate me.

Name..... Age.....
Address.....
City..... State.....

The Famous Course That Pays For Itself

“Is a 12-hour week sufficient for a man to earn a good income?”

Professor C. C. Furnas of Yale University thinks “Yes”

20^c The Copy



**DO YOU
AGREE?**

READ THIS MOST AMAZING ARTICLE IN THE CURRENT ISSUE

ARE THE
TECHNOCRATS
GENIUSES
OR
FRAUDS
?

● THEY HAVE BEEN HAILED AS BOTH. Do they plan merely to change over our economic system, or are they trying to set up a soviet of engineers? How far will they go; can they go?

IS THE MACHINE RESPONSIBLE FOR UNEMPLOYMENT?

Should we have more machines or less? Is the price system played out? Should we have electric dollars or gold? Do we need a “new deal” or a revolution? Where is it coming from?

The whole gamut of these social, economic and political problems OPENED BY TECHNOCRACY are discussed WISELY—PUNGENTLY—CLEARLY—in this and future issues of

TECHNOCRACY REVIEW

**ON
ALL
NEWS-
STANDS**

ANNOUNCEMENT

★ to men who
want careers
in **RADIO**



INTERNATIONAL CORRESPONDENCE
SCHOOLS offer a complete Radio Course
designed to give thorough instruction in
the whole field of radio. Study of it will
give you *mastery* of operating and trans-
mitting. Prepared and approved by
leading radio authorities—mail this
coupon for complete details today!

★
In the sign language
of the
Broadcasting Room
this symbol means
"Announcement."

INTERNATIONAL CORRESPONDENCE SCHOOLS

Box 6680, Scranton, Penna.

Without cost or obligation, please tell me all about the **NEW RADIO COURSE**

Name _____ Age _____

Street Address _____

City _____ State _____

If you reside in Canada, send this coupon to the International Correspondence Schools Canadian, Ltd.,
Montreal, Canada.



"Takes the Resistance Out of Radio"

Editorial Offices: 96-98 Park Place, New York, N. Y.

HUGO GERNSBACK, Editor

Vol. IV, No. 10, April, 1933

THE RADIO BEGINNER

An Editorial by HUGO GERNSBACK

WHEN radio was in its infancy,—indeed, when it still was called “wireless” as it was from the years 1903 to about 1910, thousands of young and older men, attracted by the new art, started experimenting with wireless instruments. Even during that time, there were at least 50,000 new radio beginners every year. Later on, that is, during the period from 1910 to 1921, and particularly after the vacuum tube made its appearance, and wireless became radio, there were at least 100,000 new radio beginners who joined the ranks annually. Of course, not all of these experimenters stayed with radio.—They started it as a hobby, and then, after the novelty had worn off and they had obtained all the thrills they wanted, they dropped from the ranks.

From 1921 until about 1926, there was a tremendous jump in radio activities, and at least half a million radio beginners a year joined the ranks during those boom years. After 1926, the movement tapered off, until at the present time, we seem to have an average from 100,000 to 150,000 individuals per year who are interested in radio in one form or another.

Of course, if all the old timers remained, the grand total would be tremendous; but the fact has been brought out, from observation over many years, that the activity of the average beginner doesn't last more than a year, if that long; but there are always new ones coming in, who replace those who drop out. During the past year, there has been a healthy increase, due particularly to the short-wave beginners, and those who are attracted to radio on account of amplifiers, public address systems, etc. Right now, the radio beginners, who are entering the field, seem to be not less than 200,000 a year.

In an overwhelming number of cases, the man who embarks on radio experimentation today is still intent on building a broadcast set, even as he was of yore. Things are being made much easier for him today on account of the low cost of materials, and it becomes a simple matter nowadays to build your first radio set. The attraction and mystery of radio is still there for the thousands upon thousands who have spare time, who are handy with tools, and who wish to embark upon the great adventure of radio.

The thrills for the newcomer are the same as they were of old, and if the letters received by my various radio publications are any sign, the thrill for distance, be it broadcast or short wave, is still alluring for the new crop of radio beginners. It is all right for the other fellow to tell you that he has tuned in a station a thousand or ten thousand miles away, but doing it yourself is an entirely different matter, particularly if you have built a set yourself, and have learned to master its intricacies.

The radio industry, for some reason or other, has always treated the radio beginner as the “forgotten man”; this is especially true of the parts industry which at one time

thought that everything was over but the shouting, and many parts manufacturers went out of business. Those, however, who stuck to it, have found that while the demand for parts is not, of course, as large as it was during the radio boom from 1921 to 1926, yet, since then, there has been a steady flow of business which seems to increase of late.

To be sure, there are not as many concerns in the parts business as before, due to the fact that a great many set manufacturing companies now make their own parts. During the boom years this was not true, and set builders had to buy their parts from parts manufacturers. Yet, the parts manufacturers have found that the demand for their products, from the beginners themselves, has not decreased, and even during the Depression, many radio parts manufacturers report a gain.

This is particularly true for those parts which are used in short-wave sets, amplifiers, public address systems, etc.

The reason for this is that every year there comes along a new generation of young people, a certain percentage of whom are beginning to get interested in radio, and these, of course, are the beginners. Then, too, older men are frequently bitten by the radio bug and get interested in radio from the experimental end. Usually, these men have enjoyed the experience of listening to a manufactured radio set and are normally radio fans. They become, in turn, radio experimenters, and they usually begin by building a broadcast set, anywhere from one to four tubes, of the simplest design. This is the average, because many are building very fine sets for special purposes: as, for instance, to fit special cabinets, closets, and the like.

On the other end of the scale, we find the fellow who is still willing to play with a crystal set, and believe it or not, the demand for crystal sets has never fallen off. There are as many crystal sets being sold now as there ever were, except for a short period during the radio boom.

The radio beginner these days is in a paradise of his own; he has low-priced merchandise, he has an avalanche of new radio circuits, and radio tubes of every class and variety. The old timers probably remember when we had to pay as much as \$12.00 for a single WD-11 tube. Then, the radio beginner was in the luxury class. Today, he buys radio tubes for around 35c and upwards, the average tube costing less than \$1.00.

Also, today, the radio beginner has much better instruments for a fraction of their cost than they had during the boom years, and he has the added attractions of short waves and television thrown in for good measure.

It is for this reason that I confidently expect that the radio beginners who join the ranks will keep on increasing for some years to come, and it is also for them that we have started a beginners' section in this magazine, in which we will print simple, but excellent sets for those who wish to experiment with radio and “build their own.”

Here are the New Tubes!

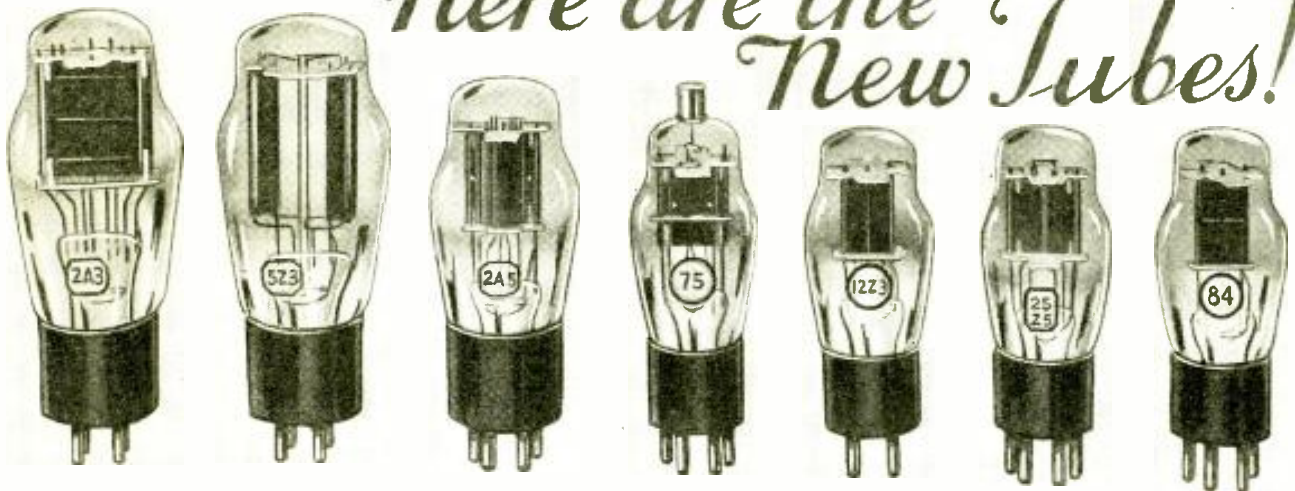

(Photographs of the 2A3, 5Z3, 2A5, and 25Z5 courtesy R. C. A. Radiotron Co.; photographs of the 75, 12Z3, and 84 courtesy Hygrade Sylvania Corp. Data courtesy same companies.)

Seven more new tubes are now available. Special detectors, special rectifiers, and new output tubes for both automotive and A.C. operation predominate. Many of these new tubes have a new numbering code. Watch this department for new tube data.

LOUIS MARTIN

SEVERAL important contributions to the vacuum-tube field have been announced during this past month. Among these contributions are included a new type high-vacuum rectifier, several new types of output tubes, and a special detector and amplifier. To understand the significance of each of these tubes, and to appreciate their place in the radio industry, the following technical information is given:

The 2A3: A Power Amplifier Triode

The 2A3 is a three-electrode, high-vacuum type of power amplifier tube suitable for use in the output stage of A.C. operated receivers. The very high power-handling ability of the 2A3 is attributed to its high mutual conductance and its unconventional cathode construction. The cathode is composed of a large number of coated filaments arranged in a series parallel combination to provide a very large effective area; the result of this construction is to produce the desirable characteristics of the 2A3.

The 2A3 fits into a standard four-prong socket, connections for which are illustrated in Fig. 1. If the tube is to be used in a horizontal position, the socket should be so placed that one filament hole lies vertically above the other. The filament of this tube is designed to operate from 2.5 volts. The transformer winding supplying the filament should, of course, deliver an unvarying voltage to the tube filament. Again, the filament winding of the transformer feeding this tube should be provided either with a center tap or with a mid-tap resistor of approximately 20 ohms, shunted across

this winding. All grid- and plate-return leads should be connected to the center tap of the winding or to the mid-point of this resistor. In some circuits, of course, it would be desirable to use a 20-ohm potentiometer and adjust the arm, to which the grid- and plate-return circuits are connected, for minimum hum.

As a power amplifier of the class A type, the 2A3 is adaptable either singly or in push-pull to the power output stage of A.C. receivers. The characteristics of this tube for these two classes of service follow:

As a single amplifier, class A, filament voltage 2.5; plate voltage, 250; grid bias, -42 volts; plate current,

60 ma.; plate resistance, 765 ohms; amplification factor, 4.2; mutual conductance, 5,500 micromhos; load resistance, 2,500 ohms; power output, undistorted, 3.5 watts.

When two such tubes are used in a class A push-pull amplifier, the following characteristics obtain: (Note: The first figure refers to a condition of *fixed bias* and the second to a condition of *self bias*. Under the self-bias condition, the values given are on the basis of *momentary average* power output, as distinguished from the *continuous average* power output of the fixed-bias condition. Under the self-bias condition, the power output and the amount of distortion present are dependent upon the duration and strength of the applied signal, which will cause a fluctuating grid bias. Under these conditions, a heavy filter condenser connected across the grid-bias resistor will minimize this fluctuating bias condition.)

Plate voltage, 300, 300; grid bias, -62, -62; plate current (per tube), 40, 40 ma.; load resistance (from plate to plate) 3,000 ohms, 5,000 ohms; power output, 15 watts, 15 watts.

It will be noted that the values recommended for push-pull operation are different from the conventional ones usually given on the basis of characteristics for a single tube. The values shown for push-pull class A operation cover operation with a fixed bias, and with self bias, and have been determined on the basis of no grid current flow during the most positive excursions of the signal.

If a single 2A3 is operated, the self-biasing resistor should be approximately 700 ohms. This same value is also recommended for use with two

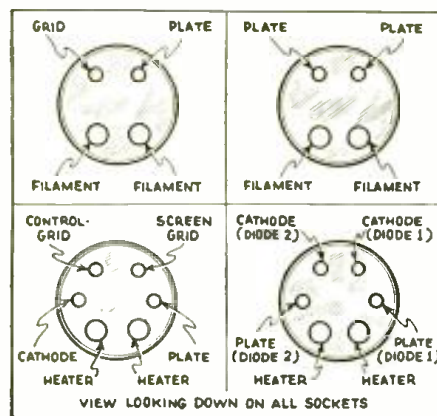

Fig. 1, upper left
Socket connections of the 2A3, direct heater.

Fig. 4, upper right
Socket connections of the 5Z3, direct heater.

Fig. 6, lower left
Socket connections of the 2A5, indirect heater.

Fig. 11, lower right
Socket connections of the 25Z5, indirect heater.

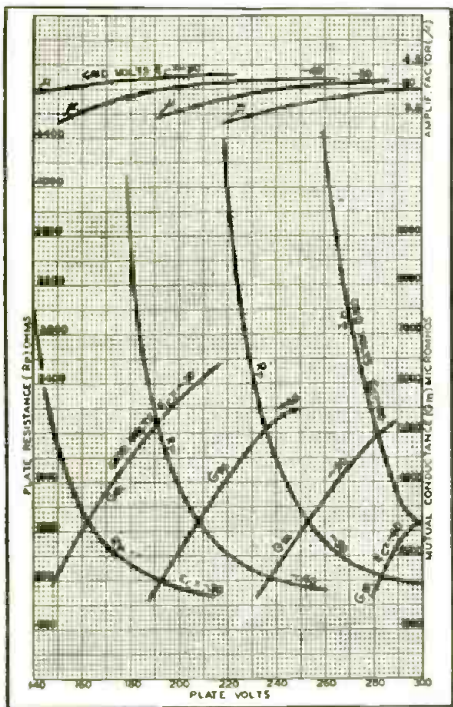

Fig. 3

A family of curves showing the variations of amplification factor, plate resistance, and mutual conductance of the 2A3 is shown here.

tubes in push-pull. In either case, the resistor should preferably be shunted by a suitable condenser to minimize grid-bias variations.

A typical plate voltage and plate current curve is shown in Fig. 2, and a family of curves showing the variation of the amplification factor, μ ; the plate resistance, R_p ; and mutual conductance, G_m are shown in Fig. 3.

The 5Z3: A Full-Wave Rectifier

This tube is a high-vacuum rectifier of the full-wave type, intended for supplying rectified power to radio equipment having very large direct-current requirements. In comparison with the 80, the 5Z3 will furnish approximately twice the D.C. load current at higher D.C. output voltages. The coated filaments employed in the 5Z3 provide an efficient source of electron emission and reach their dull red operating temperature quickly.

The following tentative rating and characteristics obtain: Filament volt-

THE NEW TUBES

The 2A3—a special amplifier triode for A.C. receivers. Heater voltage, 2.5; plate voltage, 250; grid bias, -42 volts; plate resistance, 965 ohms.

The 5Z3—a full-wave rectifier for receivers consuming a large amount of power. Filament voltage, 5; filament current, 3 A.; A.C. voltage per plate, 500; D.C. output current, 250 ma.

The 2A5—a power output pentode of the cathode type for use in A.C. receivers. Heater voltage, 2.5; heater current, 1.75 A.; plate voltage, 250; output power, 3 watts.

The 75—a special detector of the diode-triode type; similar to the 85, but the triode section has a higher amplification factor, 100. Heater voltage, 6.3; heater current, .3-A.; plate voltage, 250; bias, -2 volts.

The 1Z23—a high vacuum half-wave rectifier. Heater voltage, 12.6; heater current, .3-A.; A.C. plate voltage, 230; load current, 60 ma.

The 25Z5—a full-wave rectifier suitable for doubling the voltage from an A.C. line, thus eliminating the power transformer in many cases. Heater voltage, 25; heater current, .3-A.; A.C. voltage per plate, 125; load current, 100 ma.

The 84—a full-wave high vacuum rectifier designed for use in auto "B" units. Heater voltage, 6.3; heater current, .5-A.; A.C. volts per plate, 225; load current, 50 ma.

age, 5; filament current, 3 amperes; A. C. voltage per plate (R.M.S.) 500; D.C. output current, 250 ma.

The base pins of the 5Z3 fit the standard four-prong socket, which should be installed preferably in a vertical position, with the base of the tube down. The socket connections for this tube are illustrated in Fig. 4. If the tube must be operated in a horizontal position, then it is recommended that the filament holes in the socket should be mounted so that they are either at the top or at the bottom, i.e., so that the plane of each filament is vertical.

Filter circuits of the condenser-input or choke-input type may be employed provided the recommended maximum plate voltage and output

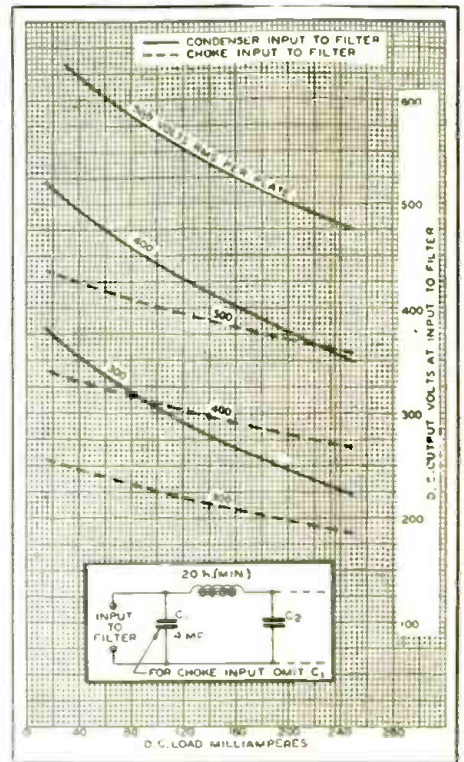

Fig. 5

Output characteristics of the 5Z3.

current, given above, are not exceeded. If the condenser input type of filter is used, it is important to recall that with the recommended applied A.C. plate voltage the filter condensers must be capable of withstanding a voltage of 700 without breakdown. It should also be noted that with a condenser input on the filter, the peak plate current of the tube is considerably higher than the D.C. load current due to the current necessary to charge the filter condensers; in fact, with a large condenser in the filter circuit next to the rectifier tube, the peak current is often as much as four times the load current.

When, however, the choke input to the filter is used, the peak plate current is considerably reduced because of the lack of an input filter condenser. A choke input filter system will give a somewhat lower D.C. output voltage than for the condenser input

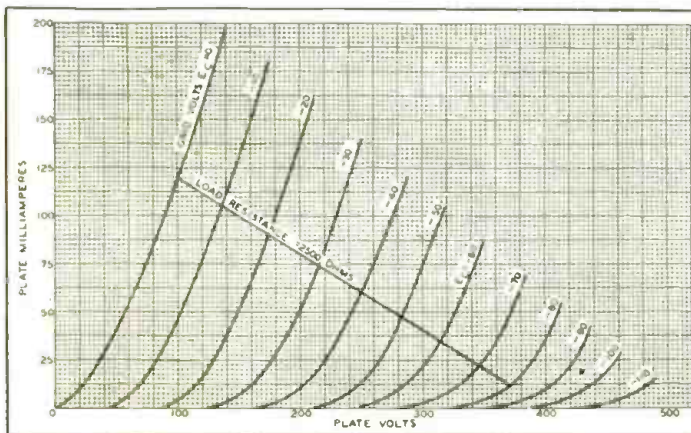

Fig. 2

A family of plate-voltage—plate-current curves of the 2A3. A load line of 2,500 ohms is shown for convenience.

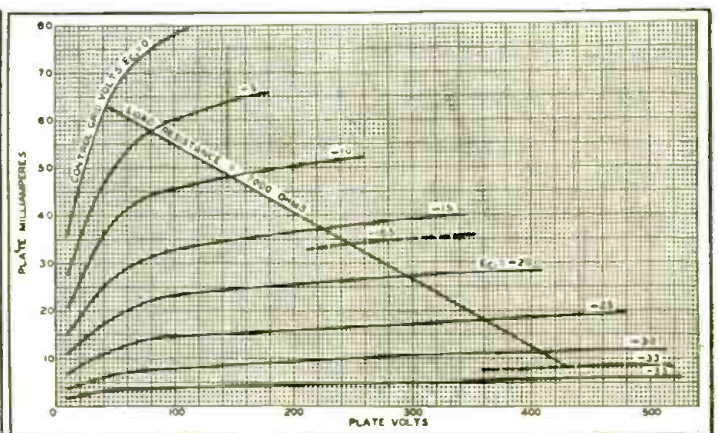

Fig. 7

A family of plate-voltage—plate-current curves of the 2A5. A load line of 7,000 ohms is shown for convenience.

system, but improved regulation will be obtained.

An interesting set of curves showing the variation of D.C. output voltage with varying load currents is given in Fig. 5. The solid lines correspond to the condenser input filter and the dash lines to the choke input filter. With a given filter system, therefore, and with the curves shown in Fig. 5, external characteristics may be predicted.

The 2A5: Power Output Pentode

The 2A5 is a power amplifier pentode of the heater-cathode type for use in the audio output stage of A.C. receivers. It is capable of delivering large power outputs with relatively small signal voltages; because of the heater cathode construction, of course, a low hum level is obtainable.

It might be stated that the power handling ability of the 2A5 is essentially the same as that of the 59 with a pentode connection; although the latter tube has a greater flexibility of application because of the fact that all grids are brought out to separate base-pin connections.

The following rating and characteristics obtain: Heater voltage, 2.5; heater current, 1.75 amperes; plate voltage, 250; grid bias, -16.5 volts; plate current, 34 ma.; screen current, 6.5 ma.; plate resistance, 100,000 ohms; amplification factor, 220; mutual conductance, 2,200 micromhos; load resistance, 7,000 to 9,000 ohms;

power output, 3 watts.

The socket connections for the 2A5 are illustrated in Fig. 6, and the tube may be operated in either a vertical or horizontal position. The 2A5 may be used either singly or in a push-pull combination. If a single 2A5 is operated self biased, the bias resistor should have a value of 408 ohms, and should be shunted by a suitable filter network, to avoid degeneration effects at low audio frequencies. The use of

or D.C.; heater current, .3-ampere; plate voltage, 250; grid bias, -2 volts; amplification factor (of the triode portion) 100; plate resistance (of the triode portion) 91,000 ohms; mutual conductance (of the triode portion) 1,100 micromhos; plate current (of the triode portion) .8-ma.; coupling resistor, .1 megohm.

The two diode plates are below the triode unit of the tube and surround a section of the common cathode sleeve. Each diode plate is brought out to a separate base pin. For further information on the application of the 75, the reader is referred to a description of the 55, which appeared in the September, 1932 issue of RADIO-CRAFT.

The cathode of the 75 should, preferably, be connected directly to the mid-tap of its heater winding. This practice follows the recommendation that no bias be applied between heater and cathode, and that the resistance between them be kept as low as possible in order to prevent hum in the circuit. Where it is impossible to follow

this rule, the heater should be biased negatively with respect to the cathode by not more than 45 volts.

Complete shielding of the detector circuit employing the 75 is generally necessary to prevent R.F. or I.F. coupling between the diode circuits and the circuits of other stages.

The 12Z3: A High Vacuum Half-Wave Rectifier

The 12Z3 is a half-wave, high vacuum (Continued on page 635)

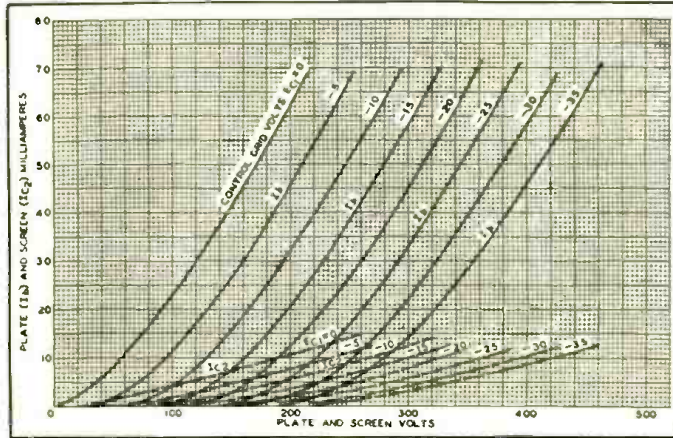

Fig. 8 An interesting set of curves showing the relation of plate and screen currents as their voltages are varied.

two 2A5's in push-pull, however, eliminate the necessity for shunting the bias resistor, which, incidentally, is now 204 ohms. The conventional type of input coupling transformer may be used, but if a grid resistor is employed in a resistance-coupled stage, its value should not exceed .25- meg.

An interesting set of curves is shown in Fig. 7. These curves show the relation between plate current and plate voltage for various values of grid biases. It is seen that with the recommended bias of 16.5 volts, which results in a plate voltage of approximately 250, the characteristic is substantially linear, resulting in a minimum of distortion.

Figure 8 shows the characteristics of this tube when the plate and screen grid voltages are varied. The solid lines represent the plate current, and the dotted lines the grid current.

The 75 Special Detector Amplifier

The 75, a product of Sylvania, is a heater type of tube embodying two diodes and a triode in a single bulb. In design, it resembles an 85, but offers a triode unit with an amplification factor of 100 as compared with a value of 8.3 for the 85. The diode units are independent of each other and from the triode, except for a common cathode sleeve having one emitting surface for the diodes and another for the triode section. This arrangement adds greater flexibility in circuit design since it permits the diodes to perform the functions of detection and automatic volume control while the triode is being used as an amplifier.

The following rating and characteristics obtain: Heater voltage, 6.3 A.C.

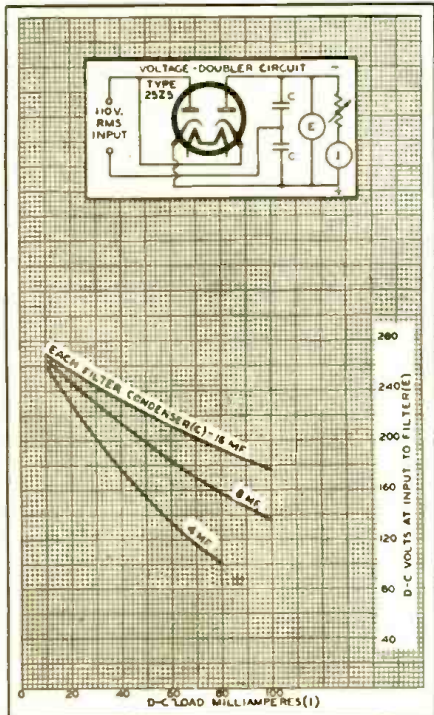

Fig. 9 Connections of the 25Z5 when used in a voltage doubler circuit. Note the filter condensers.

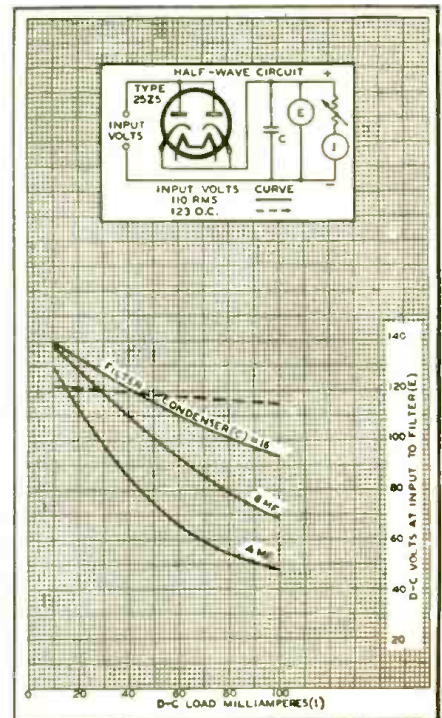

Fig. 10 Connections of the 25Z5 when used as a half-wave rectifier.

HOW TO BUILD THE POSTAL

"UNIVERSAL" KIT SET

Construction details of an up-to-the-second, high-quality, semi-assembled kit-set which may be custom-built for less than ten dollars. This tiny, nine-pound "manufacturers' model" receiver operates on A.C., D.C., or batteries, and actuates a dynamic reproducer.

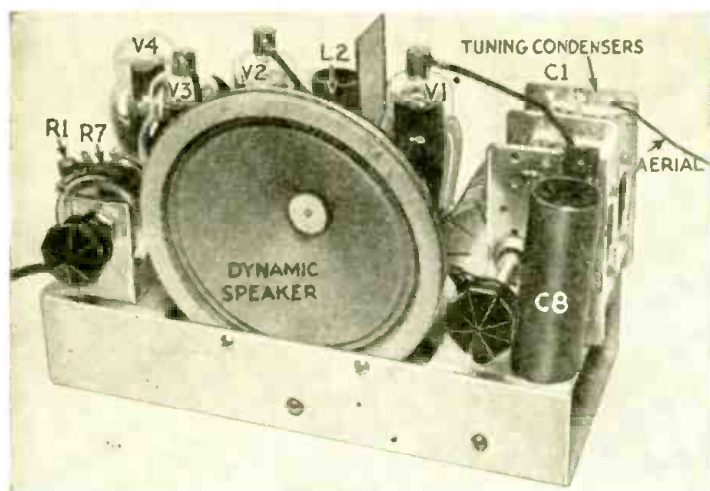

Fig. A
Panel view of the Postal model PD-2 kit set described here.

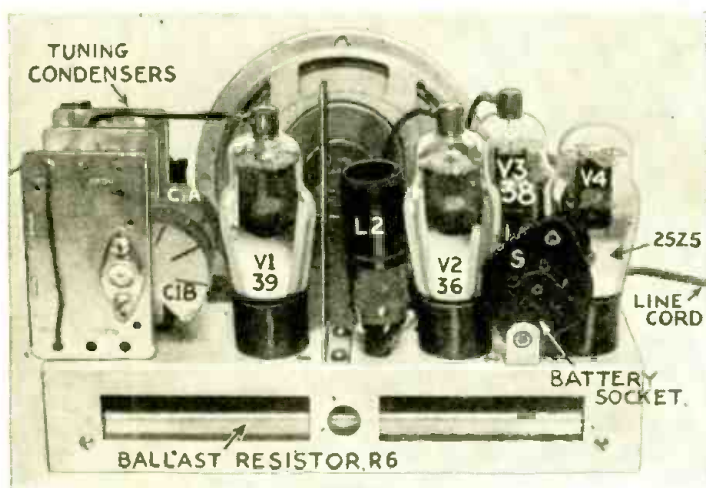

Fig. B
Rear view of the receiver showing the location of parts.

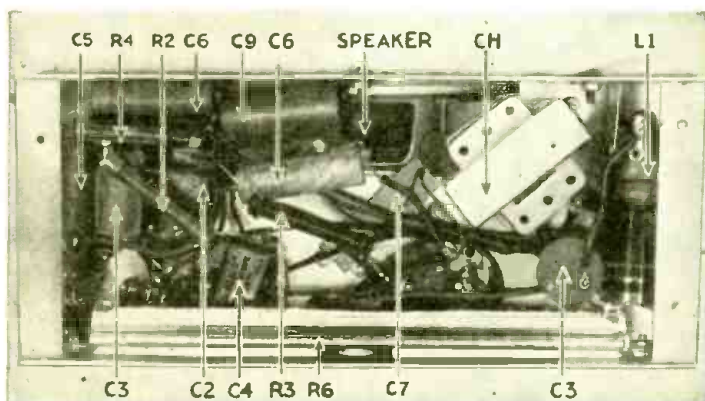

Fig. C
Under-chassis view illustrating the location of detail parts.

THE vogue in radio receiver design is the tiny set which is now being sold not only by "radio" shops but also by department stores, sporting goods houses, etc. Therefore, technicians will be extremely interested in the recent announcement that a complete, low-priced *kit of parts* for such a set is now available. This really "commercial" set may be built for less than the wholesale cost of many of the manufactured receivers.

In Fig. A is shown the front view, in B, the back view, and at C, the underside appearance of the new Postal model PD-2 "Universal" receiver which is available in semi-assembled kit form. That is, all of the larger components are mounted in position, ready to be wired. It then only remains for the constructor to wire up these units and connect into the circuit the necessary resistors

President, Postal Radio Corp.

N. M. HAYNES*

and condensers, in accordance with the schematic circuit which is shown in Fig. 1; (A picture diagram is included in each kit of parts. Incidentally, this set is available completely wired, ready to use.) The appearance of the completed set, mounted in its cabinet, is shown at A in Fig. 1; a carrying case, not shown, is available.

By reference to the schematic circuit and the List of Parts, several interesting circuit features will be noted. For instance, the new type 25Z5 dual half-wave rectifier, which is described elsewhere in this issue, is used to furnish not only high-voltage D.C. for the tubes but also high-voltage D.C. for the 4,000-ohm field coil of the dynamic reproducer.

An "Any Power" Receiver

Furthermore, the power circuit of the "Universal" has been designed to accommodate several types of power supply. Thus, those who only have access to a 6-volt storage battery may, by the use of the battery plug shown in the schematic circuit, operate all of the filaments which then are connected in parallel; "B" supply may then be obtained either from batteries, or from a special interrupter-type Postal "B" unit which operates from the storage battery, stepping up the potential from 6 volts to 180 volts, maximum.

Service Men should have no difficulty disposing of such receivers not only to the regular trade but also to automobilists, boat owners, and the itinerant commercial man who prefers to rent a storage battery rather than depend upon a light line always being available. (The model PD-2 "Universal" set may be clamped to the rug- or hand-rail of a car in a few seconds. Then, at the end of a trip it may be removed with equal ease and taken into the house and, after removing the battery adapter, plugged into the regular house lighting circuit.)

For those who reside in districts powered by Delco or other farm lighting systems, a 32 V. adapter, a 24 ohm, 50 W. Clarostat resistor (in the A+ lead) which cuts down the voltage to 6 V., is available. Still another service is that of shipboard operation, and here the current is usually about 220 V. For use on these lines, a 220 V. adapter, a 305 ohm, 50 W. Clarostat resistor which cuts down the potential to 110 V., also is available.

The ground may be connected to this set but *only* with a good (tested) mica-dielectric condenser of about .01-mf. connected in series (as shown dotted in Fig. 1) in order to provide, in the ground circuit, adequate D.C. insulation. This insulation in the antenna circuit is secured by condenser C3 which is built into the standard set. (As a "safety first" measure, the metal chassis is totally insulated from all the instruments and the wiring.)

(Continued on page 618)

MORE INFORMATION ON THE TRAUTONIUM

The fundamental theories of sound synthesis have been used by foreign engineers in the development of the Trautonium—a musical instrument. A description of two German instruments are described below. Additional data will be printed in future issues.

FRITZ NOACK, Ph.D. (Berlin)

ACCORDING to the theories of Dr. Trautwein, the tones of every musical instrument are composed of a fundamental tone, which determines pitch, and a series of overtones, which determine the tone color. Thus, every note produced by a musical instrument is not sinusoidal in character, but consists of the fundamental and its accompanying overtones; furthermore, the amplitude (strength) of the harmonics is different for every musical instrument. Each of these overtones is sinusoidal in character, varying in frequency between 300 and 3,000 cycles per second. Let us examine the method of producing sound with the throat; that is, let us see how sound is produced when one is talking or singing.

First, the fundamental tone is determined by the fundamental period of vibration of the vocal chords. These chords do not vibrate continuously, but execute sharp impacts, similar to those produced by the continual blows of a hammer upon a metal plate. The sounds produced by the vocal chords thus reach the mouth in impulses, and the mouth, in turn, by virtue of its shape which varies with muscular adjustment, has a natural period of its own. Thus, the sound emitted from the mouth depends upon the cavity formed by the individual, which also determines the strength of the harmonics produced.

Dr. Trautwein has constructed a musical instrument based upon this theory; it is shown photographically in Figs. A and B, and schematically in Fig. 1. The fundamental vibration is effected by the neon tube (glow lamp) shown at 1, and the overtones by the oscillating circuit, 2. Every oscillation impulse from

glow lamp 1 releases a damped train of impulses to circuit 2, exactly as in the case of the vocal chords and the mouth mentioned above. The resultant wave is amplified by tube 3 and conveyed via the output transformer 4 to a loudspeaker 5. The audio transformer 6 should have a

ratio of either 2:1 or 1:1, its value not being very critical. Condenser 7 should have a maximum capacity of .01-mf.; it may be variable in convenient steps. Condenser 7 and transformer 6 should be so proportioned that all frequencies between 300 and 3,000 cycles may be "tuned." Condenser 8 produces a back-coupling effect in amplifier tube 9. It should also have a maximum capacity of about .01-mf., and its purpose is to increase the strength of the overtones at will.

Operation of the Neon Tube

The glow tube operates as follows. The tube used has a starting (or ignition) potential of about 130 volts, which means a plate battery voltage, 10, of about 140 volts. Now, across the neon tube is a variable condenser, 12, and the combination of this condenser and neon tube is connected in series with the internal resistance of vacuum tube 11. The result, therefore, is a resistance-condenser oscillating circuit, the frequency of the oscillations generated depending upon the size of condenser 12 and the internal resistance of the tube, 11. The size of this condenser not only determines the frequency of oscillation, but, also, its strength. With the size of 12 fixed, the frequency of oscillation may be conveniently and uniformly varied by adjusting the value of the internal resistance of the tube, easily

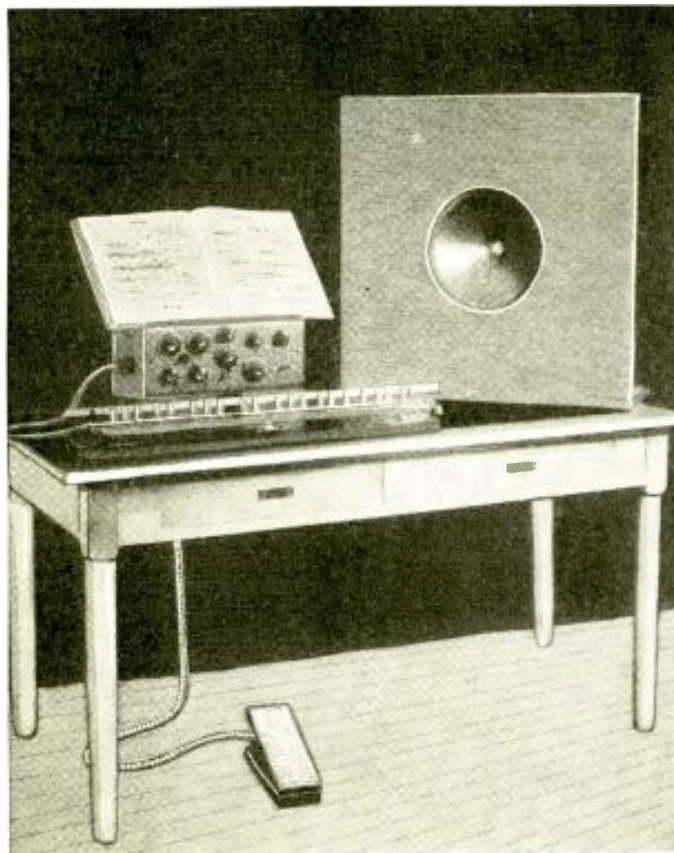

Fig. A
Photograph of the Trautonium set up with amplifier and speaker ready for operation. Note the musical scale, the amplifier, and the keyboard.

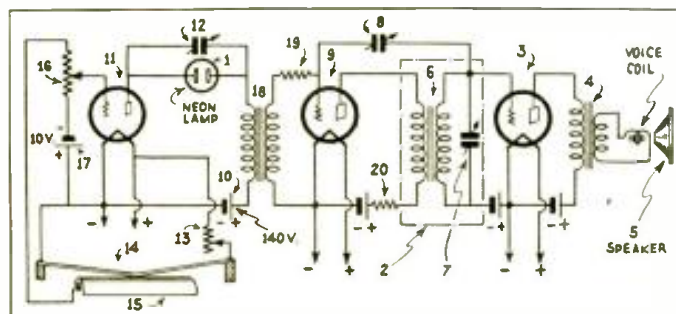

Fig. 1
Schematic circuit of the musical instrument originally designed by Dr. Trautwein. A neon-tube oscillator is used.

RADIO AND ELECTRONIC MUSIC

The field of radio is not limited to the reception of music via the air. The fundamental principles of radio have been used in almost every industry, and the production of music by radio equipment is certainly a closely allied field of the radio art. In the March issue of this publication there was described a simplified version of the Trautonium

which may easily be constructed at home and successfully operated by almost everyone. We will continue in this, and future, issues to describe musical instruments, for it is our belief that the manufacture and sale of such instruments will become one of the major avenues of revenue of the radio industry. This article is the second of a series.

accomplished by changing the "C" bias of the tube.

To accomplish this change in bias, the heaters of the tubes are connected to the "A" battery via a 10-ohm rheostat 13 and a resistance wire 14, also having a resistance of about 10 ohms. The resistance wire 14 is so stretched as to facilitate its being depressed at any point along its length against a carbon body 15 having a very small resistance, probably a few ohms. The 10-volt battery 17 is connected in series with the 30,000-ohm potentiometer, 16, and the resistance wire 14 to the heater of the tube. Thus, varying the position where the wire 14 touches 15, varies the current through the series circuit, and hence the voltage drop across potentiometer 16, causing a variation in bias, which, in turn, varies the internal resistance of the tube. The position of the arm of this potentiometer determines the volume input to the tube; that is, it determines the maximum voltage applied, *not the amount of variation.*

The oscillations produced by the glow lamp are conveyed to tube 9 by means of transformer 18, having a ratio of about 3:1; a resistor 19 is connected in series with the secondary of this transformer. This resistor, which has a value of .1-meg. is used to prevent any oscillations in tube 9 from affecting the neon tube circuit through the audio transformer 18. Resistor 20, having a value of 10,000 ohms, is used to prevent feedback when all tubes are operated from the same "B" supply.

Condenser 7 adjusts the strength of the harmonics of the oscillations produced, while condenser 8 changes the damping (the degree of impaction), so that the resultant tones may simulate any instrument desired.

The glow-lamp circuit is so adjusted that frequencies from 1 to 10,000 cycles per second may be generated. If its frequency is adjusted to a low value, and with the proper setting of condensers 7 and 8, sounds may be produced similar to that of rapid machine-gun fire, a valuable asset for theatres or vaudeville shows.

Lately, Telefunken, in Germany, has taken over the production of the Trautonium, but have revised it somewhat, as may be seen by reference to Fig. 2. One of the changes has been the conversion to all A.C. operation, although Dr. Trautwein suggests battery operation for the first two tubes, because slight fluctuations in plate voltage produce large changes in pitch.

Of particular note is the fact that the new circuit of Fig. 2 uses a thyratron instead of the neon tube. The electronic discharge of this tube, 21 in Fig. 2, takes place with condenser 22 exactly as the discharge of the glow lamp in Fig. 1. Condenser 22 has a value of .01-mf.; battery 23, a potential of 10 volts; two resistors 24, a value of 2,000 to 5,000 ohms. These two latter resistors are adjusted so that the voltage drop across resistor 25 (which has a value of 2,000 to 5,000 ohms) is about 4 volts. Item 26 is a decoupling resistor of .5-meg.; audio transformer 27 has a ratio of 3:1; potentiometer 28 should have a value of about .25-meg.; 29 is also a decoupling resistor; 30 is a 1:1 or 2:1 audio transformer; 31 is the "harmonic accentuator" circuit; 32 is a variable condenser of .01-mf. capacity. The "harmonic accentuator" is the same as that for Fig. 1, and may be directly connected into the last tube.

An additional trans-
(Continued on page 625)

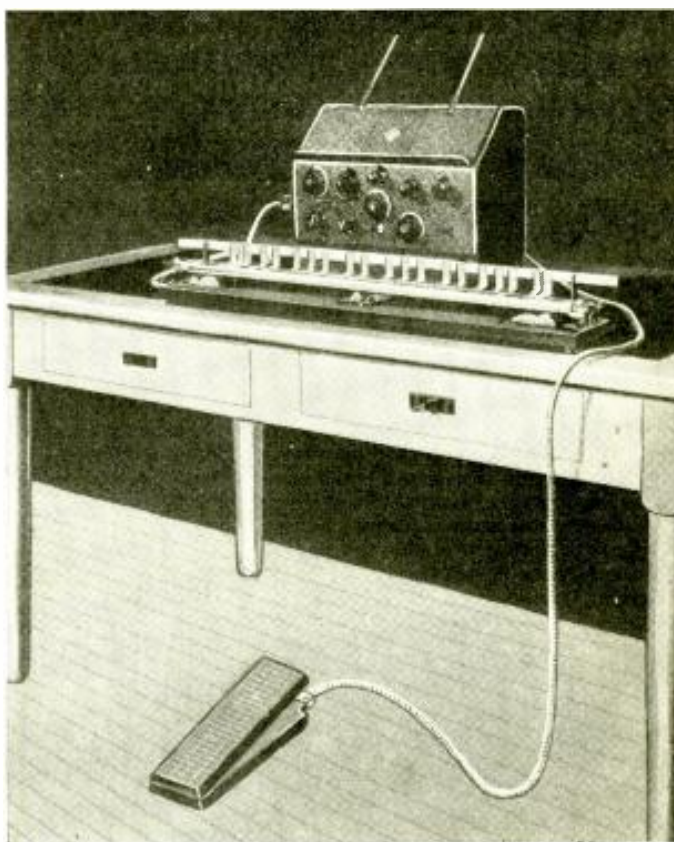

Fig. 8
Another view of the Trautonium featuring the foot-operated volume control and the keyboard. The musical scale has been removed to show its support.

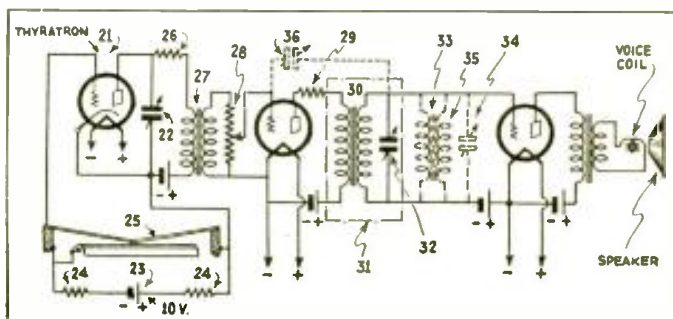

Fig. 2
Schematic circuit of the instrument as revised by Telefunken. A thyratron has been substituted for the neon lamp of Fig. 1.

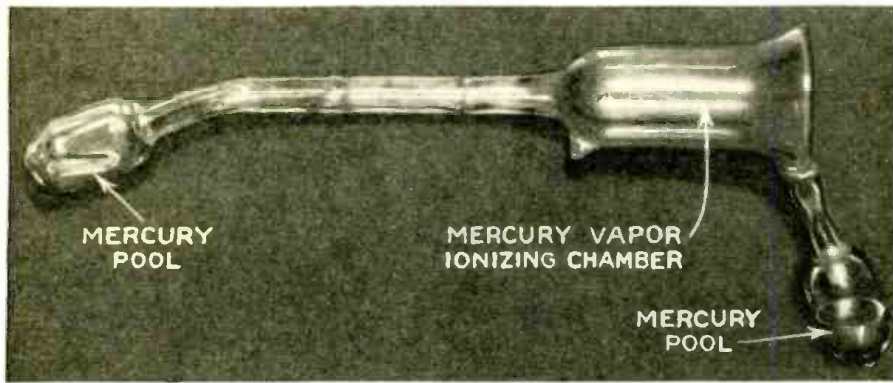

Fig. A

Photograph of the actual lamp used by Mr. Myers in his astounding experiments.

ELMAN B.
MYERS*

THE RADIOLIGHT "TALKING BEAM"

The first published detailed description of the "light beam radio" program recently broadcast over Columbia's national network. This new system utilizes a modulated 50 meter radio transmitter to produce a 375 mega-megacycle "cold-light" in a mercury vapor induction lamp. Note the fields available for this communication system.

ON the thirteenth anniversary of Vaughn de Leath's entry into radio broadcasting, her regular program over the Columbia Broadcasting Company's nationwide network was used to inaugurate a new method in radio communication. This new system is known as a "Radio Light Beam."

We have all heard much about the early experimental methods of light beam communication, and of more recent experiments with a 20 mile arc-light beam modulated by a 200 kw. transmitter; and now, through inventions in the Metal-Vapor Induction-Lamp field, this method has been brought to the point where, with only about 1 kw. in the transmitter, it will do all that a radio transmitter will do, but with a great many of radio's disadvantages overcome,—in a manner which is commercially practicable.

The lamp that is the basis of this remarkable new method of communication is pictured in Fig. A; it is sketched in Fig. 1. In the latter illustration the coils L1, L2, and the condenser C1 form the output circuit of a standard, low-power radio transmitter operating on 50 meters. The vaporizing coil L2 is coupled to the larger chamber containing liquid mercury. By the correct coupling of L2 and this mercury vaporizing chamber, mercury vapor is produced and seeks the upper or ionizing chamber. Here the mercury vapor is ionized by the 6,000 kc. (50 meter) R.F. current which circulates through the ionizing coil, L1, and produces a "cold light," of a bluish-white color, having a frequency of

8,000 A.U., or 375 mega-megacycles. Convection currents which are set up in the lamp carry mercury molecules to the second or condensing chamber where they condense, due to coolness of the quartz envelope, and form back into liquid mercury.

All that is necessary to modulate the lamp is to modulate the radio transmitter in the conventional manner. *All variations of the transmitter output are followed with absolute fidelity by the mercury vapor lamp!* In fact, the same light used in the recent Radio Light Beam tests has been used to reproduce television pictures of 60 lines, 72 elements wide, at 20 pictures per

second. This proves that the light will modulate 43,200 cycles per second, for the pictures produced were acclaimed as perfect as the originals in the television studio! It will be seen, then, that frequencies up to the limit of the audio band are well within its scope. Lamps that have been operating 7,000 hours show no signs of fatigue, and it is believed that the life of these tubes is extremely long.

Recent Demonstration

As Vaughn de Leath, 'way back in 1920, climbed the winding stairs of the old World Tower to become the first radio artist of her sex, little did she realize that thirteen years later she would inaugurate a new system of communication that is bound to open up untold transmission bands. A remarkable coincidence is that the author was at the controls of the De Forest radio transmitter which broadcast her voice for the first time!

In Fig. 2A we have a sketch, and in 2B a block illustration, of the system used January 19, 1933. Miss Vaughn de Leath and Freddie Berren's Orchestra furnished the talent, in the observation room on the 71st floor of the Chrysler Tower in New York City. The program was picked up in the regular way by engineers of the Columbia Broadcasting system, and relayed to the 65th floor of the same tower to modulate the "radio light beam." This beam of light was directed to the 16th floor of the Columbia Broadcasting Building, about a half-mile away. At the receiving point the light beam was picked up by a three-foot, water-filled lens and focused on a standard photoelectric cell. The audio output was



Fig. B

Photograph of Mr. Myers alongside of the powerful searchlight housing the mercury-vapor lamp. Note the ionizing coils.

*President, Myers Electrical Research Corp.

FIELDS FOR RADIO LIGHT BEAMS

1. For any communication system up to fifty miles that has not been able to secure a wave length from the Federal Radio Commission. 2. For a communication system between engine and caboose on some of our one and four mile freight trains. 3. Telephone and telegraph communication to and from moving passenger trains. A wide-open field. 4. In large industrial plants as a combination source of illumination and call system. 5. Shore-to-island and island-to-island telephone and telegraph communication, where the price of a submarine cable would be too costly. 6. Communication between plane and ground, and plane and plane for the passengers who are not allowed the use of present radio service, which is meant primarily for weather map data for the pilot. 7. Train dispatching. 8. Grade crossing warnings. 9. Fire-boat dispatching. (The

entire harbor can be seen from the Chrysler Tower.) This service is now by radio, and these radio channels could be relieved for other services. 10. Police services could be handled much the same as air light-beacons. Constant communication from headquarters could be maintained by talking on successive lights along our city streets. The dead spots that now exist in radio areas may obviously be completely eliminated. 11. Communication with large liners that sometimes have to wait hours to get through Quarantine. Two-way service could be used and parties on the boats connected with the Bell Telephone service throughout the land. 12. Broadcasting paid advertising, similar to our present radio advertising programs. The use of "black light" (invisible, infra-red rays filtered from the mercury light) would satisfy the City Fathers.

built up to loudspeaker volume, for a group of reporters and interested spectators, and a relay line took part of the audio to the master control room of the Columbia network where it was transmitted to the ninety-odd stations of the CBS. A transmission line used for all remote pickups was also installed between the 71st floor of the Chrysler Tower and the master control; this permitted the sound of Vaughn de Leath's voice and the music of Freddie Berren's Orchestra to be faded from light beam to wire as the announcer asked the radio audience to try to detect any change in quality.

This was a severe test but the light-beam system was so faithful in reproduction that reports from all over the country states that no difference in quality could be detected.

Figure B is an excellent view of the quartz lamp mounted in the Sperry searchlight used in the recent broadcast. The vaporizing and ionizing coils can be plainly seen around the lamp. This assembly is slung from the tuning condenser of the output circuit. The entire tuned circuit and lamp can be moved back and forth in the focus of the 24 in. parabolic mirror of the searchlight.

Figure C is a photo of the receiving equipment. The large lens was used to ensure enough light even under the most adverse conditions. It was found to be very much larger than necessary; a good signal could be picked up on a six-inch lens, at this distance. A standard color-sensitive photoelectric cell, peaked in the blue region of the color spectrum, was purchased from the American Photoelectric Corporation, and was used to convert the audio modulations of the light beam into sound. This audio signal was then sent by the regular wire line to the various stations of the CBS network, and from there into the millions of homes throughout the United States and Canada.

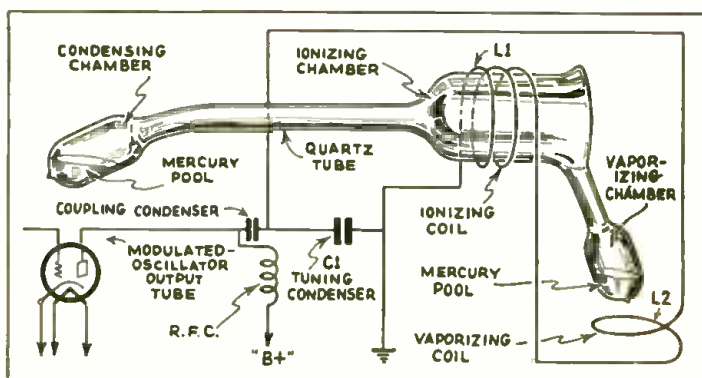

Fig 1
Schematic circuit of the ionizing circuit of the new lamp.

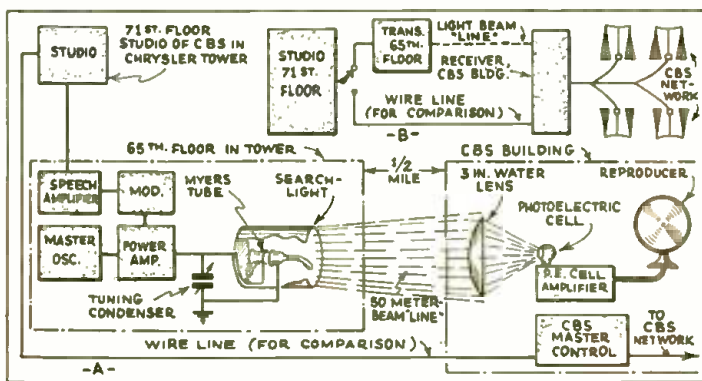

Fig. 2
Block illustration of the complete system used by CBS.



Fig. C
Photograph of the receiving lens and the photoelectric cell used in the experiments.

The distance over which this test was conducted was one of circumstance and not choice. The one-half mile in most cases would not seem "commercial," but this happened to be the distance between the two buildings. It was advantageous to use these two points—the Chrysler Tower being the locus of our laboratory, and the Columbia Building housing the CBS master control room, the main feed for the entire network. Conservative estimates, based on measurements, have shown that distances up to 10 and 15 miles can be covered with no loss in quality.

With the intrinsic brilliance developed at the power now available, we produce about 50,000 beam candle-power which is modulated 100%. Measurements are under way at the present time to establish the field intensities of the beam in the New York area. Work has been done in broad daylight with as good results as at night. Cell

rush caused by the great amount of sunlight falling on the photo-cell (also, "interfering" rays, such as those of an electric-light sign, etc.), can be balanced out by a very simple method used in all laboratories when accurate work is required.

As the driver or power-to-light converter is a standard radio transmitter, it is possible to multiplex the beam by multiplexing the transmitter by any of the well-known methods. It is possible to use heterodyne detection on the receiving end as the carrier and its sidebands appears in the output of the vacuum-type photoelectric cells. This means that the extreme sensitivity of this method of detection would greatly increase the distance over which telegraphic communication can be carried on, without increase in power at the transmitter.

A Light-Beam Radio Broadcast System
When we stop to think of the tremendous
(Continued on page 621)

THE LATEST RADIO EQUIPMENT

PIONEER GEN-E-MOTORS

A COMPLETE line of "B" battery eliminators for auto-radio use has been brought out by the Pioneer Gen-E-Motor Corp. These are compact, high-efficient machines of the dynamotor type. Outputs vary from 135 volts at 30 ma. to 200 volts at 40 ma. Drain from a 6-volt storage battery is only 1.42 to 2.75 amperes. A special 32-volt model is available for use on farm lighting plants. All models measure 4½ by 6 by 6¾ inches; average weight, 12½ pounds.

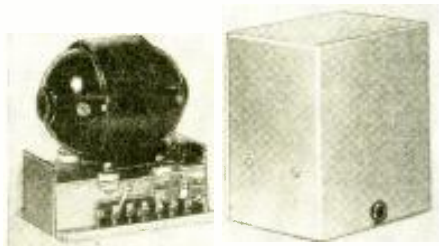

Pioneer Gen-E-Motor; case on right.

DEWALD "DYNETTE"

THE Pierce-Airo DeWald "Dynette" is a 5-tube universal A.C.-D.C. midget, measuring 11½x7x5¼ inches. Has dynamic speaker, built-in aerial, and walnut cabinet. Uses 1 - 36, 2 - 37, 1 - 38 and 1 - 39. Felt lined leather carrying case can be had.



Front view of "Dynette."

B-L RECTIFIER

THE new B-L type "F" rectifying unit illustrated below is ideal for equipment requiring a small amount of D.C. power, such as relays, electromagnetic counters, etc. The F-24 unit is rated at 2 watts, 8 volts output; input supplied by a small 110 V. step down transformer. Its size may be judged by comparison with the ruler.



WEBSTER P.A. SYSTEM

THE Webster mobile P.A. system is designed for use in sound trucks, automobiles, and permanent installations. Includes dry "B" and "C" batteries instead of converter or A.C. generator. Single cabinet houses 3-stage, 20-watt amplifier, phonograph turntable, two 12-inch dynamic speakers, double button microphone, cables for mike and speakers, etc. Entire outfit works on regular 6-volt storage battery. Dimensions, 18½x18½x31 inches; weight 90 pounds.



Mobile P.A. Amplifier by Webster.

KING COLE "A" SUPPLY

THE King Cole "A" Eliminator, made by the Anylite Electric Company, works on 32-volt farm lighting lines and furnishes filament current for any standard 2- or 4-volt broadcast receivers drawing between ½ and 1 ampere. It is equipped with a voltmeter and regulating dial; once set, the latter needs no further adjustment. A connecting cord and an on-off switch are provided.



King Cole filament supply unit.

I.R.C. RESISTOR INDICATOR

DETERMINING the value of burned out resistors is one of the most difficult jobs the Service Man encounters. The International Resistance Company comes to the rescue with a Resistor Indicator, illustrated below. This is a wire-wound 100,000-ohm resistor directly calibrated in 5,000 ohm steps. By connecting it in place of the defective resistor and adjusting a sliding contact, the Service Man quickly determines the correct replacement value.



Close-up of the I.R.C. Resistor Indicator.

PHONOGRAPH ADAPTER

THE "Diskadapt" is the answer of the New Era Specialties Corporation to the demand for a phonograph attachment that permits the use of long playing (33½ R.P.M.) records on old style phonographs. It is easily and quickly attached.

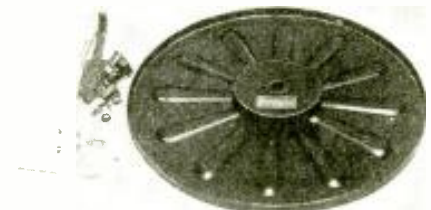

The "Diskadapt" turntable adapter.

RED DEVIL RESISTORS

THE "Red Devil" resistors made by the Ohmite Manufacturing Company are so named because of their ability to work at red heat without burning out. The 10-watt sizes, for instance, can handle 50 watts without injury. They are recommended for replacement purposes.

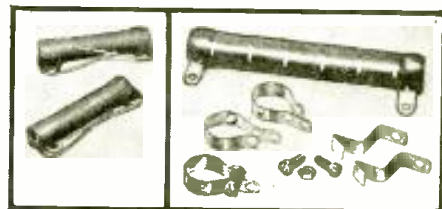

Different types of Red Devil resistors.

ADMIRALTY SUPER 15

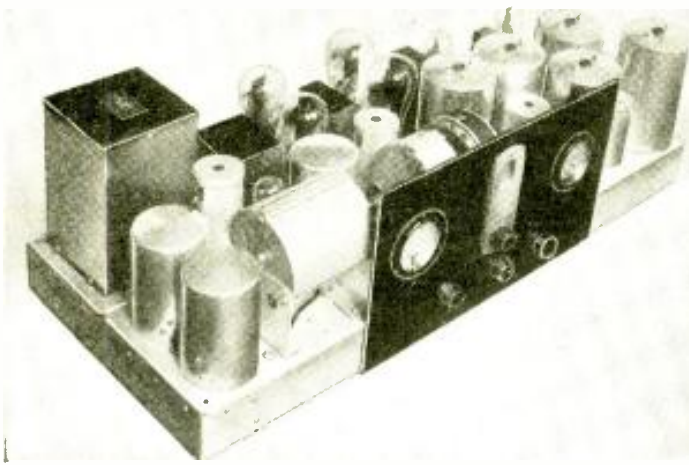

The chassis of the Norden-Hauck Admiralty Super 15.

THE Norden-Hauck Admiralty Super 15 is a high grade 16-tube superheterodyne with a wavelength range of 16 to 560 meters. It has two dynamic speakers, one pitched low and the other high, and uses band-pass tuning and the latest pentodes. The tube combination is as follows: 58 pre-amplifier, 58 mixer, 56 oscillator, three 58 I.F. amplifiers, 56 A.V.C., parallel 56's as second detector, 56 first A.F., push-pull 56's as second A.F. amplifiers, terminating in push-pull 50's. Two 81's are used in the power pack.

The mechanical construction throughout is strong and heavy. All R.F. parts are thoroughly shielded, even the tuning condensers being covered. Two meters are included on the control panel: an A.C. line voltmeter, and a plate milliammeter that acts as tuning meter. The latter is connected in the cathode return lead of the second intermediate amplifier tube. Connections are provided for a phonograph pickup.

MALLORY BATTERY CHARGER

THE new Mallory-Elkon automobile battery charger shown at the right is a very useful device for the car owner. It is equipped with convenient mounting lugs which permit hanging on wall of garage. Has 12-foot A.C. cord, and 12-foot cable with unbreakable, polarized male plug leading from charger to special receptacle on dash. Fuses for both the A.C. and D.C. circuits are mounted on top, with a spare fuse for emergency.

The heart of the charger is the well known Elkon dry disc rectifying element. The power transformer is designed to automatically regulate the output to take care of variations in battery condition and line voltage. Average D.C. output to battery is 2½ to 3 amperes. Entire unit measures 7¾ x 3½ x 3¼ inches; approximate weight 7 pounds. This charger should find a ready market among car owners who have auto radios or who make short trips.

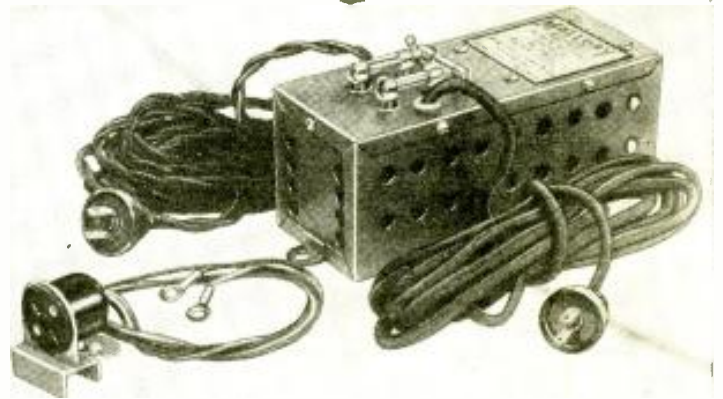

Mallory-Elkon battery charger. Dash receptacle is at left.

ROYAL A.C.-D.C. MIDGET

THE latest addition to the rapidly growing line of universal A.C.-D.C. miniature receivers is the Royal, produced by Royal Radio of New York, Inc. This is a four tube set, using 1 - 39, 1 - 36, 1 - 43 and 1 - 25Z5. It has dynamic speaker and a hand rubbed walnut cabinet. An indoor aerial consisting of 30 feet of flexible wire is permanently attached. No ground connection is needed. This set is unusually compact, measuring only 9¾ x 6¼ x 4½ inches. A decorative cloth covers the loudspeaker opening.



The Royal Midget receiver.

soldering temperature for immediate use. The result is a saving of power and increased life of the heating element. When the iron is in actual use or is placed in the right cradle, full line voltage is automatically applied to keep the iron up to maximum temperature. This stand corrects the troubles due to overheated, dirty irons, and prevents pitting and corrosion. The tip of the iron will remain well tinned for weeks.

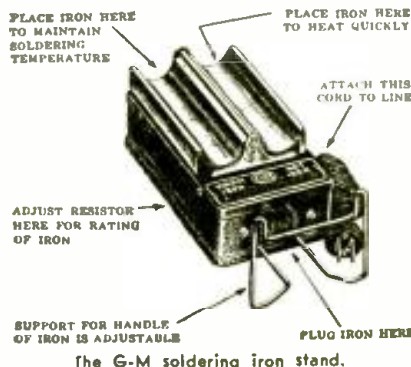

NEW AEROVOX RESISTORS

THE Aerovox Corporation has brought out a new line of adjustable Pyrohm (vitreous enamel) resistors designed to meet all voltage divider requirements and other uses where adjustable heavy duty resistors are required. By means of a special method, a narrow strip of the winding along the length of the unit is left free of enamel in order that contact may be

made with the adjustable slider. However, while the surface of the wire is exposed, the enamel between turns holds the wire firmly in place and prevents inter-turn short circuits. These new resistors are available in 25, 50, and 75 watt sizes.



Aerovox wire wound resistors.

NA-ALD ADAPTER



New Na-Ald adapter

WITH the new Na-Ald adapter pictured at the left, you can test the new 25 and 30 volt tubes in old type tube checkers. The type 48 tube can be checked in the 27 socket of the adapter; the type 43 can be similarly tested. A 60 watt lamp is needed in the first case, and a 40 watt in the second.

SOLDERING IRON STAND

THE G-M Laboratories announce a new type of soldering iron stand that effects a saving of 30 to 40% in power consumption and overcomes many of the principal soldering troubles. This stand has two cradles. When placed in the left cradle, the iron receives only sufficient voltage to keep it at the minimum and yet proper

HOW TO MAKE A MODERN BENCH-TYPE TEST PANEL

Here is a test panel that satisfies every need of Service Men. It contains every piece of test equipment that is usually required by Service Men. Complete constructional details and parts list are given. Only a single meter is used in the entire panel.

F. L. SPRAYBERRY*

RADIO Service Men have long felt the need of having a complete shop work-bench on which practically all the equipment required for modern radio receiver servicing could be mounted. In most shops, testing equipment and associated apparatus with which a Service Man works may be found in several different places, and, often, much time is wasted in locating this equipment and getting it set up for a particular measurement. *If all test apparatus could be incorporated on one panel, and on one workbench, the Service Man would save much time (and therefore money), besides having his shop appear workmanlike and efficient.* (Space on the table is then available for tools, the receiver chassis, etc.)

The writer has had many requests from Service Men in all parts of the country for detailed construction data relating to such a panel, and, since these requests have been so insistent, considerable time has been spent in designing and building such a panel. The diagram of this panel is shown in Figs. 1 and 2; a picture of the front of the panel is Fig. A, and a rear view, Fig. B.

Referring to Fig. 1, at A is shown an A.C. operated, A.F. modulated R.F. oscillator having a range from 100 to 1,500 kc. This range will cover not only the broadcast band, but, also, all intermediate frequencies in general use. At B is shown a tube checker. At C is shown an amplifier having microphone, phonograph and radio receiver input connections. At D are shown two output transformers, a speaker field with load resistor, and a broadcast coil with its tuning condenser. At E is shown a pre-heater arrangement. At F is shown a short-checker. At G is shown an adjustable condenser bank, varying in capacity from .05- mf. to 8 mf. At H is shown the power supply for the entire panel.

*Sprayberry Radio Data Sheets.

Figure 2 is the schematic circuit of a set analyzer which will test all tubes and circuits which have been announced to date.

The whole of this apparatus is mounted on a Spaulding bakelite panel, measuring 18 x 30 ins. At the rear of the panel is a large wooden baseboard which also measures 18 x 30 ins. On this baseboard are mounted the amplifier, power supply, adjustable condenser bank, filament transformers, and other heavy parts. Leads are brought out from these to different controls and connections on the panel. All of the instruments associated with the panel are operated from the control knobs, switches, etc., mounted on the panel.

The various units of this panel are so arranged that, for economy, the complete panel may be built in sections. That is, if the Service Man has a certain amount of money to spend, in one month, for test equipment, he may build one section of his panel that month and some other section another month, until the complete job has been assembled.

By inter-connecting the various units of the panel, many test combinations are

possible. It is quite easy to substitute the parts on the panel for parts in the receiver which you may suspect are not working properly. Since binding posts are available on the panel, which connect to the various panel parts, substitution of parts is quickly and easily made.

You will notice that *only one meter is used for the entire panel.* This instrument, a Weston Universal model 301, rectifier type, may be used as the output meter for the oscillator, the A.C. or D.C. meter for the analyzer, the milliammeter for the tube tester, and the voltmeter for the ohmmeter; or, it may be used for other external voltage or current measurements, whether A.C. or D.C.

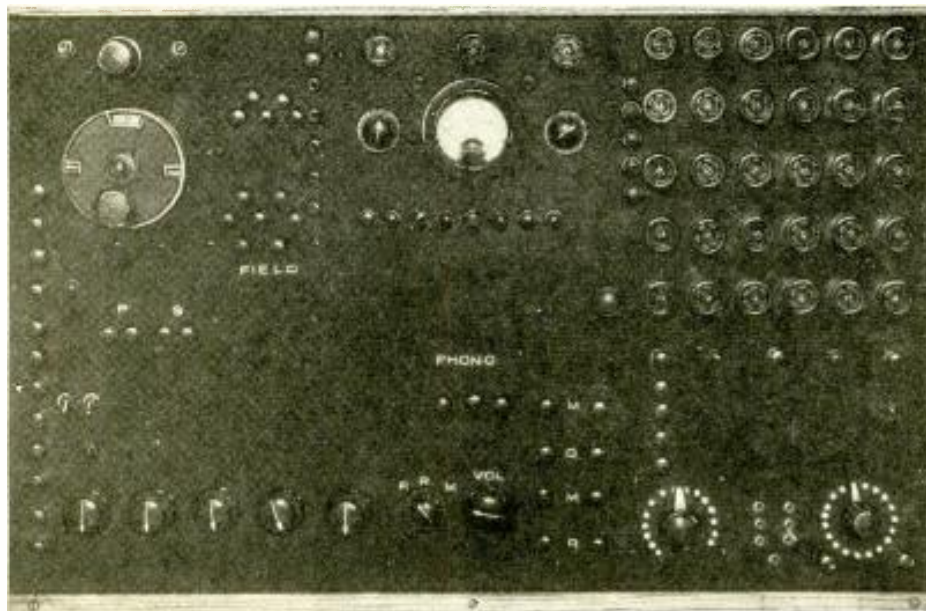

Fig. A

Photograph of the front panel of the ultra modern test panel described by the author.

The Oscillator

The oscillator (the schematic circuit is Fig. 1A) is inclosed in a 6 x 9 aluminum shield box which is mounted in the upper left-hand corner of the panel and held in place by means of four machine screws in each corner. That end of the shield box which is nearest the panel must be so arranged that the controls of the oscillator extend through both the shield and the panel, as shown in Fig. A. Near the top of the box a tap-switch control is provided to change the range of the oscillator. Just under this switch is located the oscillator tuning condenser. Leads are brought out from the side of the oscillator box for the phonograph pickup and R.F. feed line connections. These leads terminate at binding posts provided along the left side of the panel. A small 15 ohm variable resistor controls the output of the oscillator, or, in other words, acts as an attenuator. The shaft for this control must also extend through the aluminum box and panel so that the strength of the oscillator may be varied.

The coil form for the oscillator should be 4 ins. long and 2.5 ins. in dia.; it is wound with 300 T. of No. 30 D.S.C. wire, constituting coil L1 in Fig. 1A. Taps are provided at the 56th, 158th, and 238th turns for the different ranges; these taps are controlled by switch Sw. 1. Counting from the cathode end of the coil, tap No. 1 connects to the end turn and covers the 100-113 kc. range; tap No. 2, at the 238th turn, covers the 122-150 kc. range; tap No. 3, at the 158th turn, covers the 240-400 kc. range; and the 4th tap, at the 56th turn, covers the broadcast band from 550 to 1500 kc.

The tickler coil L2 should consist of about 100 T. wound directly over the center of the secondary coil. The small coupling or primary coil L3 should consist of about 25 T. wound directly over the grid end of L1.

This oscillator is so designed that practically any desired frequency in the I.F. or R.F. bands is obtainable. Although fundamental frequencies are not provided for in every band, the oscillator is rich in harmonics and any desired frequency (within the limits of the oscillator) may be obtained by using these harmonics.

(It is necessary to calibrate the oscillator but this will not be covered here as as directions for doing this have been given in past issues of RADIO-CRAFT. See, for instance, the article, "How to Make and Calibrate a Service Oscillator," by Clyde J. Fitch, in the August, 1932 issue.)

Constant modulation is obtained for the oscillator by closing switch Sw. 2, which connects the .01-mf. condenser from the grid to the plate of the modulator tube. When modulation is desired by means of a phonograph pickup, Sw. 2 is opened.

In many cases, the Service Man will want to provide his own broadcast signal, feeding it through the various stages of the receiver under test. Thus, he does not need a strong signal from a broadcast station to test the receiver. This, too, makes it possible to have a signal for test purposes any hour of the day or night.

To provide this R.F. signal energy, it is only necessary to couple the output of the oscillator to the antenna and ground posts of the receiver and close switch Sw. 3. The phonograph pickup is then placed in operation and the electrical variations from the record will then modulate the R.F. oscillator so that a modulated signal, just like that of a broadcast station, is applied to the receiver.

The tuning condenser of the oscillator controls the point on the receiver dial at which this signal is received. If you want a signal at 550 kc., for instance, just tune both the oscillator and the receiver to this frequency. If you want a modulated signal in the I.F. band, couple the

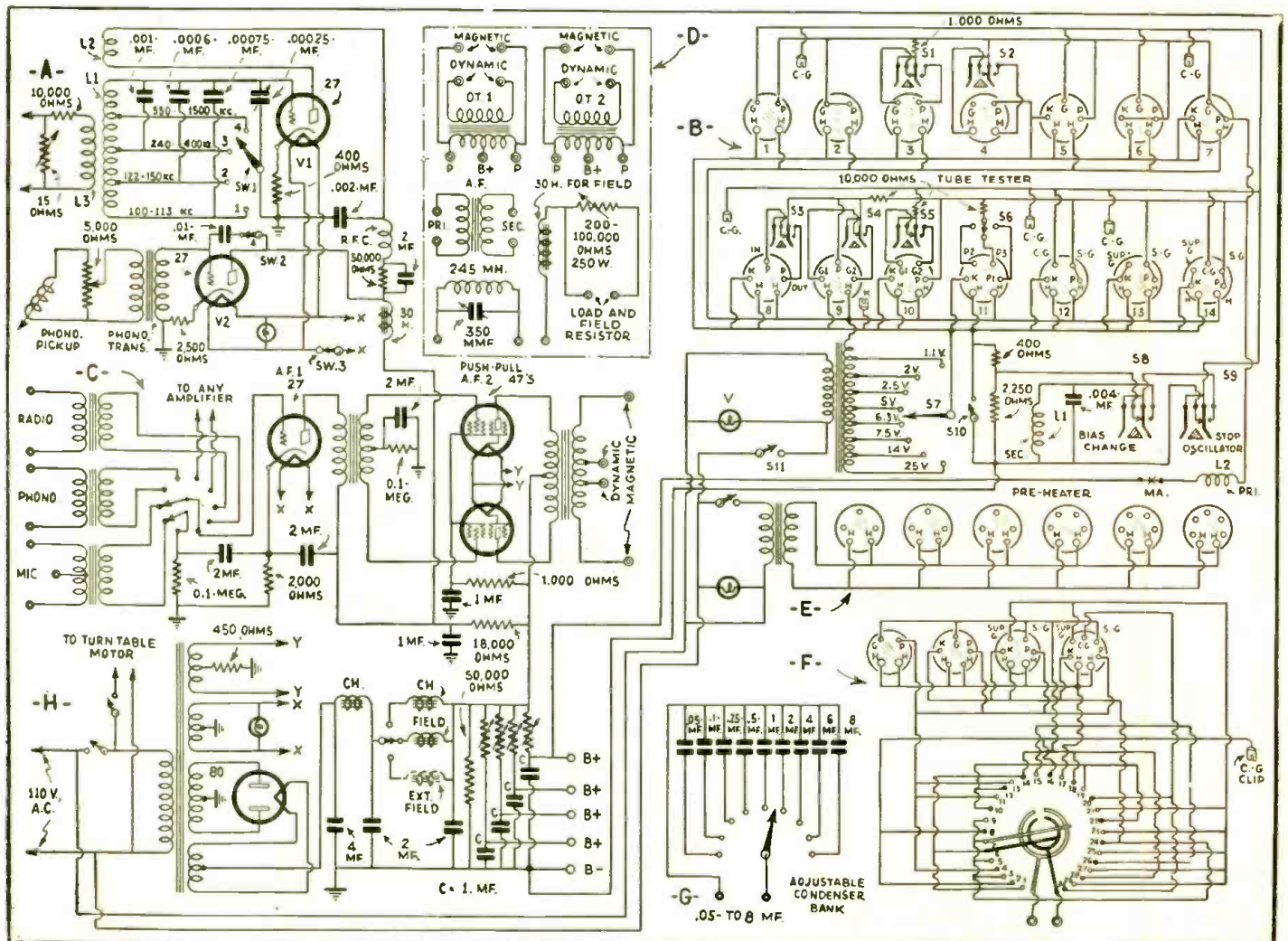

Fig. 1
Complete schematic circuit of the test panel; all values are given in the List of Parts at the end of this article.

oscillator to the input of the I.F. amplifier in the receiver and tune the oscillator to the intermediate frequency of the receiver.

Whether using the R.F. or I.F. bands, the relative gain-per-stage in the receiver is easily determined in terms of the output meter reading. For instance, if all stages are working properly, an increased reading on the output meter will be obtained as each amplifier stage is included in the test. First, couple the oscillator to the input of the detector. (If a "super" is being used, you will, of course, couple to the second-detector.) Set the attenuator of the oscillator to give a normal reading on the output meter and do not change the volume control setting on the receiver. Carefully note the output meter reading and then couple the oscillator to the preceding R.F. or I.F. stage. When this is done, an increased reading should be obtained on the output meter. If none is obtained, then the stage preceding the detector gives a "loss" rather than a "gain."

(If it is definitely ascertained that a loss is being indicated in the circuit, the procedure then is to locate the defect before continuing further with the test. On the other hand, if a gain is noted, then the stage must be O. K.)

Next couple the oscillator to the tube preceding the one just tested. Continue this method of coupling to tubes in the receiver until the R.F. tube in the antenna circuit has been reached. Such a test will not be applicable to the oscillator circuit but, if desired, the service oscillator may be substituted for the oscillator in the receiver. The test oscillator must be tuned to a frequency differing from the R.F. signal by an amount equal to the value of the resonant frequency of the intermediate-frequency amplifier (in

FEATURES OF THE PANEL

- (1) An A.C. operated, A.F. modulated R.F. service oscillator covering the range of 100 to 1,500 kc.;
- (2) A one-meter set analyzer, the meter of which is used for continuity testing and for all current and voltage measurements from 2.5 ma. to 100 ma. and from 5 V. to 1,000 V., respectively, on the entire panel; as an output meter or ohmmeter (the ohmmeter range using a 4½ V. battery is 500 to 100,000 ohms, high-range, and 10 to 500 ohms, low-range). The analyzer is designed to test all the circuit arrangements that have been designed to date;
- (3) A tube checker that will test all the new tubes which have so far been designed. Fourteen sockets and a switching system are provided for this purpose. In addition, there are available the following: (a) an oscillation test for all tubes; (b) A pre-heater for all of the heater type tubes; and (c) a short-checker that will check every element of a tube against the remaining elements for possible short-circuits;
- (4) A power unit to supply current for all the component parts of the tester;
- (5) An A.F. amplifier (with a gain of over 60 db.) provided with phonograph, radio set and microphone input equipment with various other special connections which the Service Man or experimenter requires on his workbench;
- (6) A universal-type output transformer, and a field coil of the most generally-used design, so that the Service Man does not have to remove the dynamic reproducer from the receiver cabinet when he is servicing a radio set;
- (7) A variable 80 watt resistor for use where it is desirable to load a circuit;
- (8) Various types of A.F. transformers equivalent to those which a Service Man encounters in his work;
- (9) A condenser bank, adjustable from .05- to 8 mf., for testing filter circuits in power packs, receiver and amplifier units;
- (10) A coil-and-variable condenser combination, resonant to the broadcasting band, for checking suspected tuned circuits.

most commercial sets, about 175 kc.).

You can also get a very good idea of the condition of the tubes in the receiver by using this oscillator. In this case, constant modulation is obtained by closing switch Sw. 2 between the plate and grid circuits of the modulator (do not use the phono. pickup). After the oscillator has been coupled to a particular stage, several tubes might be tried in that stage and the one which gives the highest reading on the output meter should be permanently used in the circuit.

The Set Analyzer

The analyzer, which is shown by diagram in Fig. 2, is placed at the top-center of the panel, as shown in Fig. A. The meter is in the exact center with the switches and other parts extending both to the right and left. The sockets are placed just above the meter near the top of the panel. One socket is a combination 4, 5 and 6-hole type. The other socket is of the 7-hole type.

In the picture it will be noticed that *three* sockets are provided on the set analyzer. However, only two are really necessary. The model illustrated in Fig. A was constructed by the writer before the "combination" and 7-prong sockets became available. The picture does not show S16 as this is an improvement added later, after this model was constructed.

However, there is plenty of room on the panel for this switch which, besides its being a two-deck unit instead of a three-deck, is similar to S15 and S18. For these reasons the text of this article will differ slightly from the picture. Voltage-range switch S15 is located to the right of the meter while current-range switch S18 is to the left. Just to the left of switch S18 are located five tip-jacks, and two binding posts for the 4½ V. battery.

Notice that di-

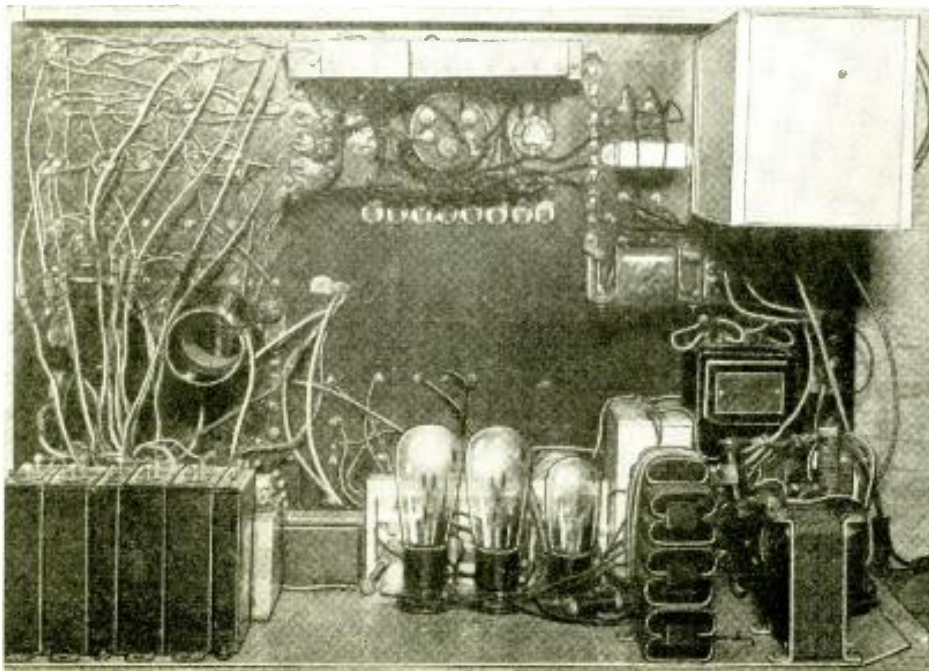

Fig. B

Rear view of the test panel; note the arrangement and accessibility of all parts.

rectly underneath the two sockets (three, in Fig. A), are located two tip-jack control-grid connections; two are provided merely for convenience. At the right side of the analyzer are located the current switches S12, S13 and S14. Two of the D. P. D. T. switches, S5 and S6, are also located in the row with the current switches. Just under the meter are located the other switches for controlling the various operations of the analyzer.

At the bottom of the panel, just to the right of the tube checker and between two multi-contact switches, will be seen seven tip-jacks into which are plugged the leads of the cable from the 6-prong analyzer plug.

Switch S1 in Fig 2, measures A.C. filament voltage when S5 is turned to the A.C. position. Switch S2 measures the total D.C. voltage existing between grid and plate of any tube; when making this measurement, S5 must be in the D.C. position. To measure the total A.C. voltage across the plates of rectifier tubes, S5 is set to the A.C. position and switch S2 is depressed. In this connection, switch S15 controls the voltage range of the meter whether the measurement is A.C. or D.C.

Switch S3 reverses the polarity of the meter when making a D.C. voltage measurement. In any case, if the meter reads in the reverse direction, depress switch S3.

Switch S5 determines whether you measure A.C. or D.C. values. The normal position of this switch is for D.C. measurements.

Switch S6, which is set normally for voltage measurements, is provided for protection to the meter when making current measurements. To make a current measurement, turn this switch from V., the normal position, to the opposite position, A., and select the current range of the meter by means of switch S18.

Switches S7, S8, S9, S10 and S11 are D.C. voltage measurement switches for determining the voltage of the various circuits of all tubes. These five switches are operated in connection with switches S15 and S17. The function of switch S15 is to change the range of the voltmeter from 5 V. to 1000 V., as follows: position No. 1, 5 V.; 2, 10 V.; 3, 50 V.; 4, 100 V.; 5, 250 V.; 6, 500 V.; 7, 750 V.; 8, 1000 V.

The function of switch S17 is to connect the meter-return lead to either the filament or cathode circuits; the F position is for tubes of the direct-heater type, such as the O1A and 71A, and the K position for tubes of the indirect-heater type, such as the 27 or 24.

Getting back to the function of switches S7, S8, S9, S10 and S11, these are depressed, one at a time, to make voltage measurements only after S15 and S17 have been set correctly. The circuits are tested in the following sequence: switch S7, plate voltage; S8, cathode or pentode screen-grid voltage; S9, control-grid or screen-grid voltage; S10, suppressor-grid voltage; S11, control-grid voltage measurement. Remember, if in using any one of these five switches, the meter reads reverse, depress switch S3 which will cause the meter to read in an up-scale direction.

Switches S12, S13, and S14 are current measuring switches for determining the current in the various circuits of all tubes. These three switches are operated in conjunction with switches S6 and S18. To make a current measurement, turn S6 to the current position and select on S18 the desired range, either 2.5 ma., 25 ma., or 100 ma. If the control-grid or screen-grid circuit current measurement is desired, depress S12; cathode or pentode screen-grid, S13; plate S14. For full-wave rectifiers, one plate current measurement is obtained by depressing S14 and the other by depressing S12; for half-wave rectifiers, depress only S14.

Switch S16 is of the two-deck type, having three fixed contacts and one movable contact for each deck. Position No. 1 of this switch changes the control-grid voltage of three-element tubes by an amount equal to the voltage of the "C" battery. This causes a change in plate current which is a figure of merit (the "mutual conductance" figure in tube tables) for the type of tube under test. Usually, the greater the change in plate current, the better the tube. Position No. 2 changes the control-grid voltage for screen-grid tubes, likewise causing a change in plate current.

Position No. 3 permits continuity testing and the use of the meter as an ohmmeter when test leads are connected to the "+D.C., A.C." and "-D.C." tip-jacks. Then, turn S5 to "D.C." and S6 to "V." To measure higher values of resistances, use a larger battery and set switch S15 to the correct voltage position. The value of the resistance under test will be equal to $R_X = E/I - R$. Where R_X is the resistance under test, E is the voltage of the battery, I the current of the meter and R the resistance of the meter. The resistance of the meter will depend upon the position of switch S15. If a 90 V. battery is being used, switch S15 will, of course, be in the 100 V. position; con-

(Continued on page 626)

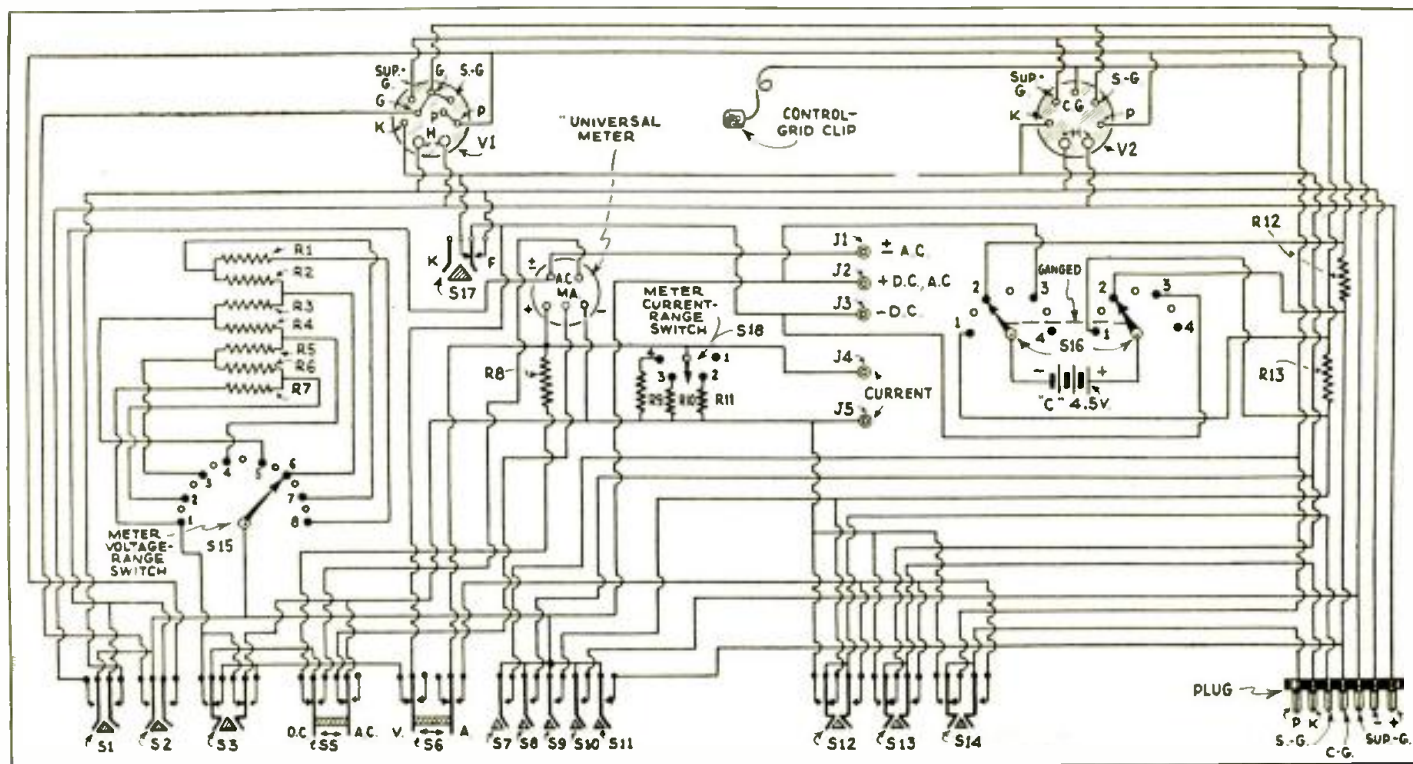

Fig. 2

The above circuit is a detailed drawing of the analyzer section of the test panel.

HOW TO BUILD A 110-VOLT TRANSFORMERLESS RECEIVER

Employs a dynamic speaker and uses the latest rectifier, 25Z5, and a 43 tube providing 900 milliwatts of undistorted output.

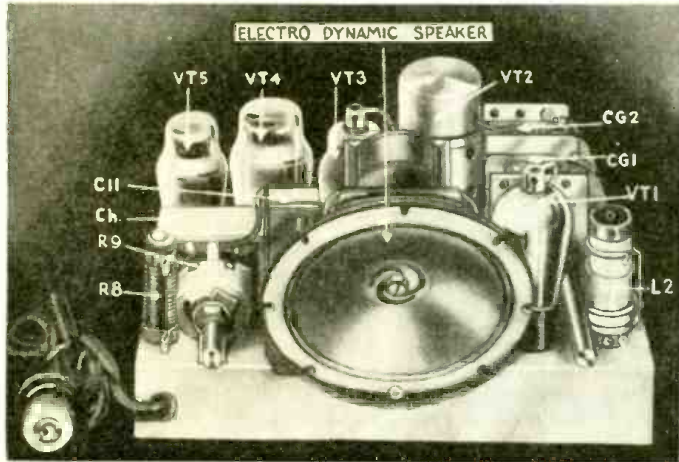

Fig. A
Panel view of the miniature receiver by Coast-To-Coast.

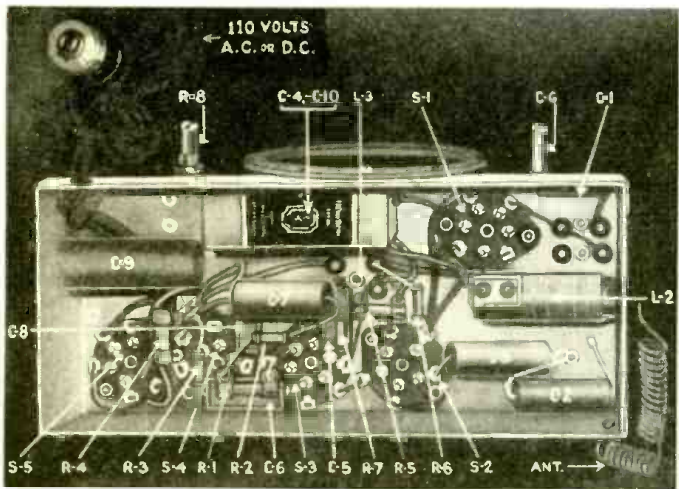

Fig. B
Under-view of the chassis; all values are marked thereon.

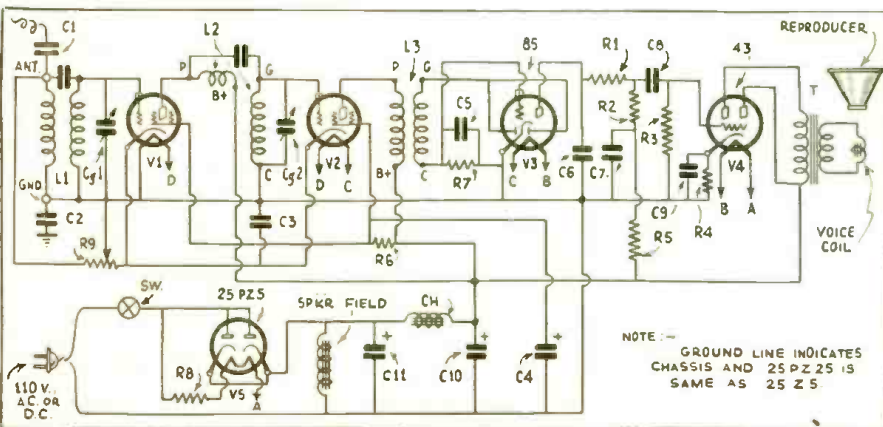

Fig. 1
Schematic circuit of the receiver discussed in the text.

LEON J. LITTMANN, E.E.*

THE overwhelming sales response given to the recently marketed series of "ultra-compact personal" radio receivers that may be operated equally well from both 110-volts A.C. and D.C. has opened a vast new market and substantial money-making opportunities for the professional set builder and Service Man.

The writer has made a thorough study of many existing models of universal A.C.-D.C. receivers for the purpose of gleaning, from each, their particular "virtues," combining them into a homogeneous unit, and adding thereto a few valuable improvements of his own. He can truthfully say that the performance of this remarkable receiver warrants the approval of the most discriminating purchaser.

In addition to unusual circuit design, this remarkable receiver has been possible because of the advent and development of several recently perfected new tubes, small dynamic speakers possessing greater efficiency, a novel all-purpose filter design, compact component parts, large capacity low voltage electrolytic condensers, etc.

The outstanding feature of this set is, of course, its universal operation. It can be plugged into any 110-volt D.C. or A.C. receptacle, without throwing any switches or without making any changes whatsoever within the receiver. It should also be noted that the circuit design permits the use of an A.C. source of any frequency whatsoever, (20, 25, 40, 50, 60 cycles, etc.). It is also well to mention that this receiver can be used on a six-volt storage-battery-operated power unit delivering 110 volts for use in an automobile. The Coast-to-Coast Auto A.C. Unit, suitable for this work, has been fully described in the November, 1932 issue of RADIO-CRAFT. This receiver can also be connected to any 220 to 250-volt line by employing an ordinary 50-watt line resistor of 275 to 300 ohms.

As the circuit employed dispenses with the use of a power transformer, it eliminates the danger of breakdown and burnout. The breakdown of A.C. operated receivers is caused, almost invariably, by the power transformer. We wish to draw the attention of the reader to the fact that

the omission of the power transformer is a most desirable feature with respect to cost. We even dare to prophesy that the various manufacturers of tomorrow will make serious efforts to dispense with power transformers wherever possible. This set has another important advantage in that its total power consumption is less than 40 watts, resulting in a small electric bill, which factor is to be considered when operating several of these receivers continuously at the same time. Because of this small power consumption, there is much less heat to be dissipated, which results in cooler and more reliable operation. There are several miniature sets now on the market whose designers did not take these

(Continued on page 620)

*Chief Engineer, Coast-to-Coast Radio Corp.



ACTIVITIES OF THE OFFICIAL RADIO SERVICE MEN'S ASSOCIATION

DURING the year 1932, the OFFICIAL RADIO SERVICE MEN'S ASSOCIATION, organized in 1930, has greatly increased its activities, as well as its membership. The membership as of February 1, 1933, totaled over 16,000, making it the largest radio service organization in the world today.

This organization is now supplying handsome membership certificates to all members, and certificate No. 10,000 was mailed to Mr. Thomas S. Sigl, of Marshfield, Wisconsin. In commemoration of this event, a photograph of the original was taken and a reproduction of same appears on this page.

By special decree of its directors, the OFFICIAL RADIO SERVICE MEN'S ASSOCIATION now also accepts Associate members. The difference between a full member and an associate member is that the full member must pass a rigid technical examination by filling out a questionnaire of some sixteen questions, and he is not accepted as a full member unless these questions are satisfactorily answered.

Associate Members are now being accepted by the Association merely by filling out a questionnaire of past experience and training in the radio servicing field.

If the blank containing this information is filled out, the applicant becomes an Associate Member immediately; but

the certificate, as well as identification card, etc, are marked "Associate Member" to distinguish him from the full member.

The Association has also published its own magazine recently under the title of OFFICIAL RADIO SERVICE MEN'S BULLETIN. This is a tabloid paper of eight pages, and is jammed full of important information for Members and Associates.

The Association also furnishes special letterheads and business helps to its members and associates, assists them with their local advertising, and furnishes them with all sorts of literature necessary in their business.

The OFFICIAL RADIO SERVICE MEN'S BULLETIN, in its first issue, started a campaign to rid the country of the so-called "gyp" Service Men who are advertising "Free Service." The BULLETIN contends that there is no such thing as "Free Service," and that Service Men who so advertise are out to fleece the public.

The OFFICIAL RADIO SERVICE MEN'S BULLETIN sells at 10c a copy; \$1.00 a year to non-members, and 50c a year to members.

If you are interested in the Association, write to the Executive Secretary, OFFICIAL RADIO SERVICE MEN'S ASSOCIATION, 98 Park Place, New York, N. Y.

NEW ANALYZERS FOR OLD

A description of the problems encountered in remodeling old test equipment to facilitate their use in new circuits. This description covers the Jewell 199, 408, 409, Weston 537, 547 and Supreme 99A, 400A, and 400B testers. Models 33 and 44 ohmmeters are included.

H. G. CISIN, M.E.

MANY radio Service Men are unaware of the fact that out-of-date Diagonometers, set testers, and analyzers may be modernized at comparatively slight cost. Due to differences in design, some test instruments lend themselves to the rejuvenating process more readily than others; but there is no reason in the world why a Service Man should continue to fuss and bother with an obsolete analyzer patched up with numerous adapters. Instead, he can have the instrument converted or re-manufactured into a new, modern instrument, or in some cases he can do this for himself.

Under a plan recently inaugurated by the Supreme Instruments Corporation, this concern will re-manufacture, or modernize, old Diagonometers, such as the 99-A, 400-A, and 400-B models, Jewell Pattern 199 Analyzers, Weston Model 537 Set Testers, etc. The method employed is to utilize as much of the old equipment as possible, supplying additional ranges to the meters, increasing the number of functions of the D.C. meters, adding ohmmeter ranges, furnishing modern selector switches, installing sockets for the new tubes, attaching a more comprehensive analyzing cable, and arranging all parts on a bakelite panel, which is mounted in a handy carrying case.

As a typical example of what can be accomplished in the line of modernizing old test equipment, the procedure will be outlined which is followed in converting a Supreme model 400-B Diagonometer into a new 1933 Supreme model 401 Radio Analyzer.

The model 400-B employs a four-scale A.C. voltmeter, a "1000-ohms per volt" D.C. meter and a third meter. The first two instruments are re-utilized in the new 401 model, while the latter is discarded. The A.C. voltmeter is used without any changes in its original ranges. As in the old-style model, all ranges of the meter are available at bakelite-insulated pin-jack terminals.

The D.C. meter is provided with a new dial calibrated to perform four separate functions: first, it contains four D.C. voltmeter ranges. These are 0 to 10, 0 to 100, 0 to 250 and 0 to 1000. In the original instrument, the separate D.C. voltmeter also had four ranges, but 750 volts was the highest voltage reading possible.

The principle involved in multi-scale meters is very simple. Closing the "10 scale" switch automatically brings a corresponding meter resistance into the circuits involved. The value of this resistance is such that whatever voltage under 10 is applied to the meter circuit will deflect the meter needle a distance over the meter dial in proportion to the voltage applied. In this case, 10 volts applied, will give a full-scale deflection; 5 volts a half-scale deflection, etc.

Closing the "100 scale" switch automati-

cally brings a corresponding meter resistance into the circuit, the value of this being such that whatever voltage under 100 volts is applied to the meter circuit will deflect the needle over the dial in proportion to the voltage applied. Hence, in this instance, 100 volts gives a full-scale deflection, 50 volts a half-scale deflection, etc.

Same Meter Also Used as Milliammeter

The second function performed by the D.C. meter is that of measuring current. In the 401 job, the instrument is provided with calibrated scales to measure three ranges: 0 to 10, 0 to 100, and 0 to 250 milliamperes. The principle employed to obtain a multi-range milliammeter is just as elementary as that used for the multi-range voltmeter. In this case, a series of suitable shunt resistors are employed.

The third function of the D.C. meter is its use as an output meter. In this case, the four D.C. voltmeter ranges are utilized in connection with a full-wave rectifier and a blocking condenser, thereby providing four output meter ranges. The desired range may be connected (1) between the plate terminals of push-pull power tubes; (2) between the power tube plate terminal and chassis of radio sets which utilize a single power tube; or (3) across voice coil terminals for output measurements during the usual radio re-adjustment operations.

Fourth, ohmmeter ranges are added, and this new function constitutes a valuable improvement over the old tester. The model 400-B did not have a direct means of measuring resistances. Instead, a resistance-current graph was furnished, so that the resistance could be obtained indirectly from a current reading. For high resistances, a method of calculating was necessary, after first taking a voltmeter reading.

In the new model 401 Radio Analyzer, direct ohmmeter readings are obtained. The distribution of the markings of the "OHMS" range is made as uniform as practicable, and large figures are used, so as to provide easy readability of resistance values within the usual working distances between the user and the meter. The multipliers and the shunt resistors of the ohmmeter circuits are extremely accurate, and the average internal resistance of the self-contained 4.5-volt flashlight battery is compensated for in the calculation of the resistor values, so that the battery resistance does not enter as an error in the ohmmeter indications. A variable meter shunt adjustment is provided for

compensating for the diminished battery potential, so that the ohmmeter indications remain very accurate within the useful potential range of the battery. The variable shunt adjuster for "zero-ohm" settings is much more accurate than the variable series method of bat-

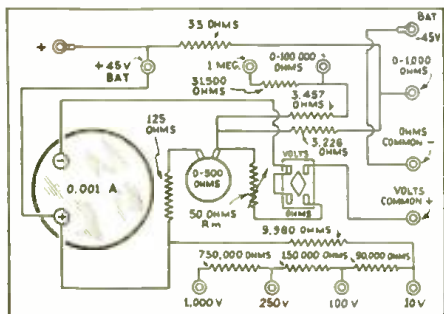

Fig. 1

Internal connections of the Supreme model 33 ohmmeter illustrated in the photograph on the opposite page.

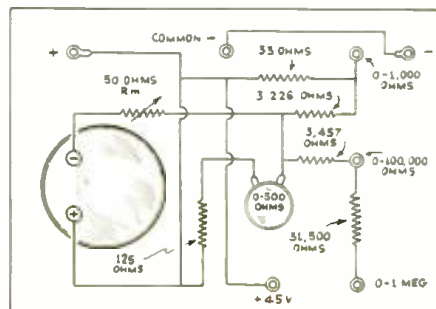

Fig. 2

Internal connections of the Model 44 volt-ohmmeter photographically illustrated on the opposite page. All values are given.



From left to right: Supreme's models 90, 62, 33, 44, and 77 "revamped" testers.

tery compensation in which the variable series resistor introduces an appreciable error. For measurements of resistance values between 100,000 and 1,000,000 ohms, facilities are provided for externally connecting an ordinary 45-volt battery. The low range, between 0 and 100 ohms, is very useful for all continuity testing, the lowest division being 1 ohm, with the 35-ohm marking at the center of the scale. The medium range, between 1,000 and 100,000 ohms, meets practically all radio servicing requirements.

The connection of the "zero-ohms" adjuster in series with a fixed resistor is shown in Fig. 1, which illustrates the circuit connections of a typical ohmmeter, the Supreme model 33. The 500-ohm rheostat connected in series with the 125-ohm metallized resistor constitutes a variable of from 125 to 625 ohms across the effective 50-ohm movement of the meter, thus adjusting the sensitivity of the meter to varying battery potentials. The series voltage divider resistors of 33 ohms and 3,226 ohms, and the 3,457-ohm multiplier resistor for the higher resistance-measuring ranges have an accuracy tolerance of $\frac{1}{2}$ of 1%. The circuit diagram in Fig. 1 gives a clear conception of the additional resistors required to use the D.C. meter as a direct-reading ohmmeter. Note that a small variable resistor is placed in series in the negative lead of the meter to adjust the meter to an exact internal resistance value of 50 ohms.

Figure 2 shows the internal connections of a Supreme model 44 D.C. Volt-Ohmmeter. This diagram demonstrates the practical application of the principles outlined above for utilizing multiplier resistances to extend the range of a voltmeter. The instrument employed in the model 44

serves only two functions, whereas the same type instrument in the re-manufactured model 401 serves four functions.

Returning to the description of the improvements incorporated in the latter analyzer, a rugged four-position, selector switch is utilized for successively connecting the two D.C. meter terminals to the four functional circuits described. Since the full-scale current of the meter is only one milliamperere (.001-amp.), there is no appreciable potential drop across the contacts, so that practically no error is introduced by contact resistance.

The next important step is to discard the obsolete tube sockets and install four new sockets for accommodating all 4-prong, 5-prong, 6-prong and 7-prong tubes. An eight conductor analyzing cable is then connected to the corresponding terminals of the sockets and to the pin jack terminals to which any range of the meters may be connected for any desired resistance, potential, or current measurements; and to which the self-contained battery, or any battery, may be positively or negatively connected for tube testing, regardless of which terminals may represent the controlling grid elements of the tubes. The extreme flexibility of this arrangement assures the owner of the model 401 Radio Analyzer that the re-manufactured job is far less likely to become obsolete than the older types of analyzers.

Finally, the various parts are symmetrically arranged on a bakelite panel and mounted in a suitable carrying case having a slip-hinged cover. The flexible analyzing cable with the moulded bakelite analyzing plug and snap-catch plug adapters occupy an unusually large compartment,

(Continued on page 634)

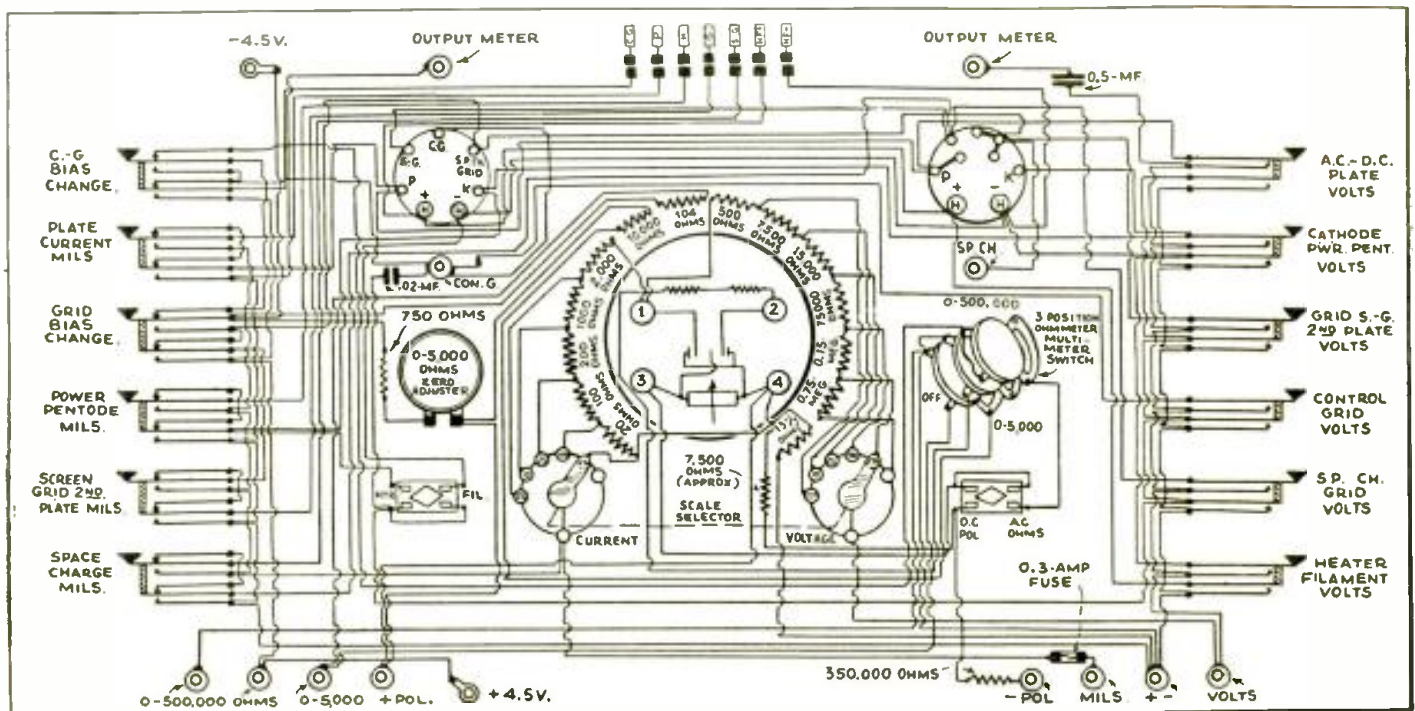

Complete schematic circuit of the Supreme model 90 set analyzer "revamped" to take care of the latest circuits.

NOW!
BUILD

THE MEGADYNE "N" RECEIVER

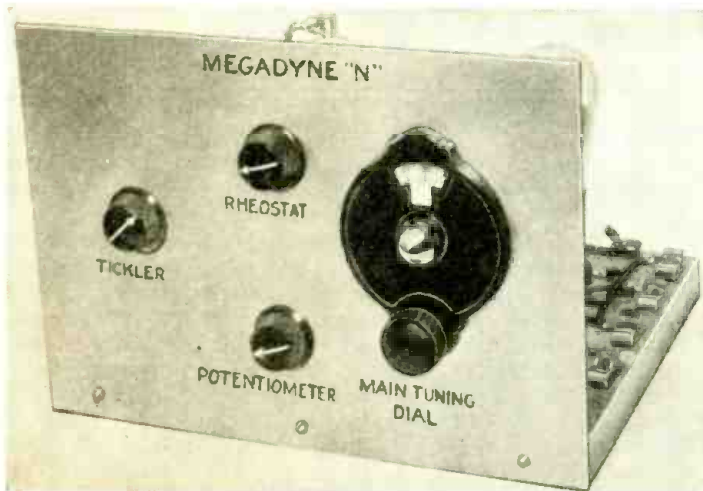

Fig. A
Front panel of the Megadyne "N" showing all controls.

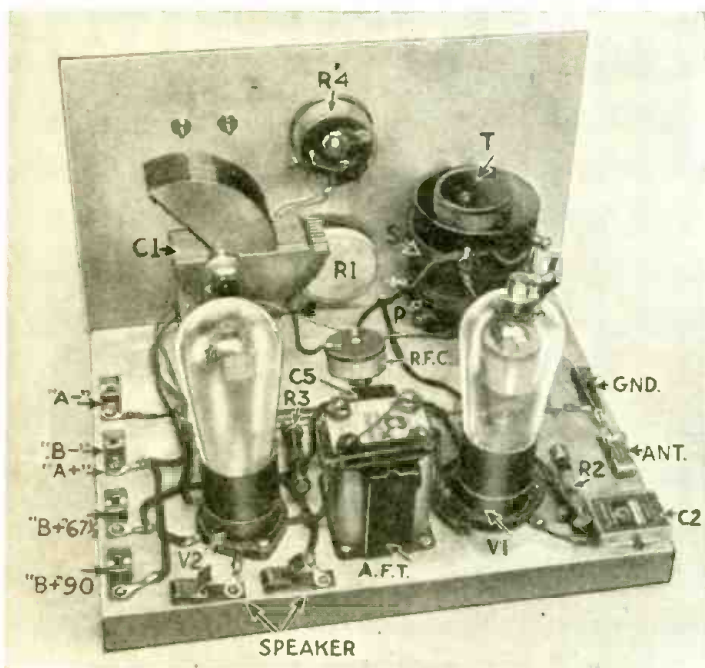

Fig. B
Rear view of the set. The labeling corresponds to Figs. 1 and 2.

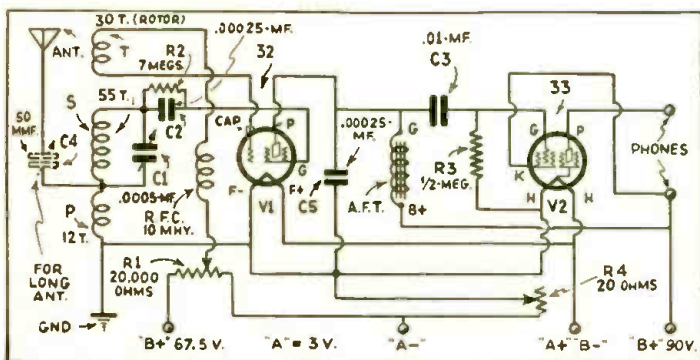

Fig. 1
Schematic circuit of the Megadyne "N" designed by Mr. Gernsback.

Here is one of the most remarkable circuits that we ever came across. It has unheard of sensitivity, and literally has all 96 channels of the country on its dial. The set is so sensitive, it will bring in some of the locals without aerial or ground. It is particularly suited to get distant stations, and will outperform any similar set that has been described.

HUGO GERNSBACK

SINCE I described the MEGADYNE one-tube loudspeaker set in the July and August, 1932, issues of RADIO-CRAFT, many radio fans and experimenters have built this set or made variations in the circuit. Recently, one of my readers, Mr. George A. Peterson, of Eastend, Sask., sent in a circuit in which he incorporated the Megadyne with the old "N" circuit, which was in vogue some years ago. In his letter, Mr. Peterson stated that he was about 150 miles away from the nearest broadcast station, and he wanted a circuit that would bring in stations with satisfactory volume. The receiver was built in our laboratory, but I did not find it to be quite satisfactory, as it was somewhat tricky. I then made my own modifications, and the present receiver is the result of a month's work to produce something that is quite outstanding in results.

Indeed, I may say that this set, in its final analysis, has me stumped; because, for sensitivity, I have never heard the like of it. This set is so sensitive that it borders on the unbelievable. Turning the dial from one end to the other there is a whistle on practically every spot of the dial, and I am sure that all the 96 channels in the United States can be heard on this set when it is working normally. Indeed, the sensitivity is so extraordinary, that the battery set I describe here can be used without any aerial or ground whatsoever, and it still will bring in the locals loud and clear on head receivers, and some of the locals on the loudspeaker, and all on two tubes!

The set is ridiculously simple to build, and the parts can be obtained by anyone without much trouble. No special parts are necessary, and only a reasonable amount of care in building the set is required.

Our technical readers will note that the tuned circuit is a variety of the "N" circuit, and that the primary and secondary of the loose coupler are joined together, the aerial making connection at the junction of the two. The tickler is in its usual place, with the exception that the plate connection does not go to the tickler; the screen grid is substituted, which is, of course, the Megadyne connection. The entire combination gives rise to a most sensitive combination because advantage is taken of the space charge of the screen-grid tube, and a multiple oscillatory circuit is produced, which is exceedingly effective.

As a matter of fact, the oscillations of this set are so powerful that the major difficulty was to find a way to control the regeneration.

Description of the Set

The set requires only a wooden baseboard and an aluminum panel, in addition to the apparatus. A front view, as well as the back view, is shown in the accompanying

THE RADIO BEGINNER

• In this department we shall print every month simple, but effective radio sets and circuits, and other information for radio beginners, or those just starting in radio. There are thousands of radio fans and experimenters who are still interested in building their own, and

in experimenting with home-made sets. The new instruments, as well as the new tubes, make this endeavor of particular importance.

If you build the sets described in these pages, won't you be good enough to advise us what results you are getting?

photographs, Figs. A and B, of the set. It will be seen that the set is tuned by a single master control, which is the tuning condenser. There are three other knobs on the panel, but only two are actually used. The rotor of the loose coupler is set for maximum oscillation and then never touched. The set cannot, as a matter of fact, be tuned advantageously by turning the rotor of the loose coupler, as this is not permissible in this circuit.

The other two controls are the filament rheostat control, which is the top center knob; and the lower center knob; and the lower control, the potentiometer, which controls regeneration. More of this later, however.

A schematic circuit of the set is given in Fig. 1, and for convenience in wiring, a pictorial diagram, which shows the approximate location of all the parts and their connections, is shown in Fig. 2.

Now, refer back to the schematic diagram. We find that the antenna is connected to the junction of the primary and secondary of the loose coupler, the bottom coil being labelled "P" (primary), and the upper one "S" (secondary). It will be noted by the dotted lines that we have a variable condenser, in the aerial circuit, which is to be used only if you have an antenna more than 50 feet long. It may be a small "postage stamp" condenser, but it is not used if your aerial is less than 50 feet in length. Again referring to the schematic circuit, we find the topmost coil, labelled "T"—the tickler. These three coils constitute the coils of the standard three-circuit tuner of conventional design, and I am giving the data herewith if you wish to build it yourself:

The primary, P, consists of 12 turns of No. 24 single-silk-covered wire on a cardboard tube 2½ inches in diameter and 2½ inches long. Spaced about ¼ inch from this winding is the secondary, S, consisting of 55 turns of No. 24 single-silk covered wire. The tickler, T, consists of 30 turns of No. 24 single-silk covered wire

wound on a small rotor 1½ inches in diameter and 1¼ inches high. This rotor should be able to rotate 360 degrees so as to make one complete turn, and is manipulated by the small knob shown to the extreme left on the panel photograph.

The set is tuned by the large variable condenser labelled C1, the knob of which is the main tuning control shown in the front view of the set. The knob in this instance, of course, is attached to the vernier for easier tuning. After the set has been built, as I have stated before, the tickler control is never used once the best setting has been found. Usually, the tickler windings are parallel to the secondary windings, not at right angles, for best results. After the set has been wired and is in operation, you will find that the set oscillates violently, and that the entire dial is chuck full of whistles—each whistle, in this instance, being a station. It is merely necessary, then, to use the regeneration control, that is

Results With Megadyne "N" In One Hour All Stations Brought in with Fair Speaker Strength

Dial	Station	Location
92	WMCA	New York City
70	WSM	Nashville, Tenn.
69	WOR	Newark, N. J.
62	WJZ	New York City
54	WHAS	Louisville, Ky.
47	WABC	New York City
35	WTAM	Cleveland, Ohio
38	KDKA	Pittsburgh, Pa.
36	WHO	Des Moines, Iowa
30	WRNY	New York City
26	KYW	Chicago
24	WTAM	Cleveland

the potentiometer, R1, moving it very slowly in order to clear each whistle. The purpose of this potentiometer is to vary the voltage applied to the control grid of the first tube, V1.

As may be seen further from the schematic circuit, the receiver also has an audio transformer—which may be anyone on hand since it is not used as a transformer, but as a choke. The schematic will make this point clear. An examination of this portion of the circuit will show that the

F-terminal of the secondary of this transformer is directly connected to the P (plate) terminal of its primary. The B plus post on the transformer is connected to the plus of the "B" battery. Transfer of energy from tubes V1 to V2 is made via the coupling condenser, C3; the grid of V2 connects to the filament through resistor R3. The filaments of the two tubes are connected in parallel and then to the "A" battery through a

(Continued on page 631)

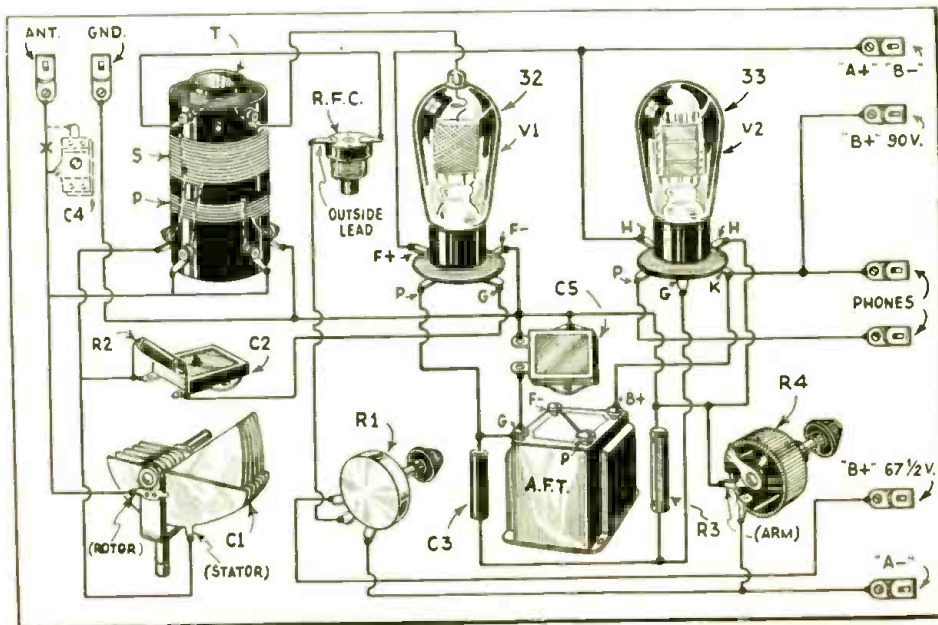

Fig. 2
Pictorial view of the set showing the connection and position of all parts.

CONSTRUCTING A SIMPLE, MODERN TUBE TESTER

Here are complete constructional details of a really modern tube tester that tests all the latest tubes without the use of any adapters. This tester is one of the few that may be built at home at a cost that will insure a good return on its investment.

MILTON REINER*

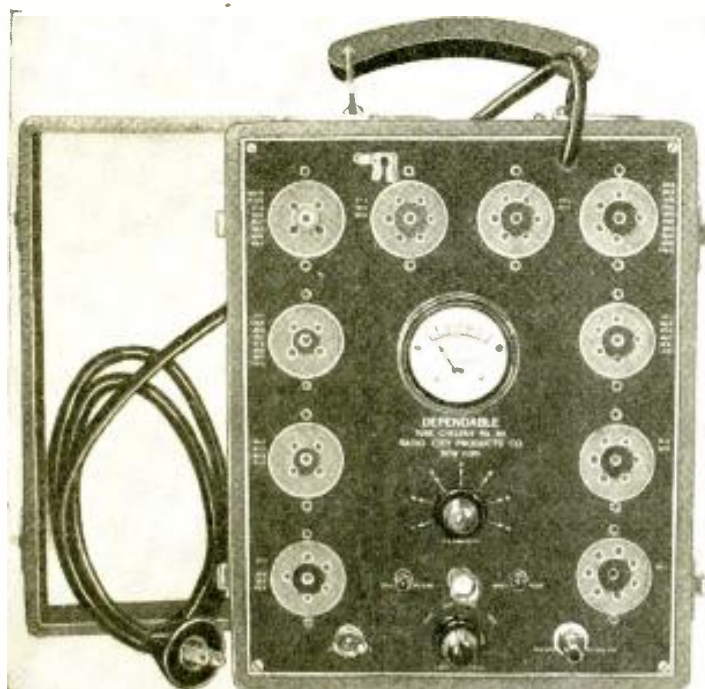

Fig. A

Photograph of the completed Dependable tube tester described. All lettering is referred to in both the List of Parts and in Figs. 1 and 2.

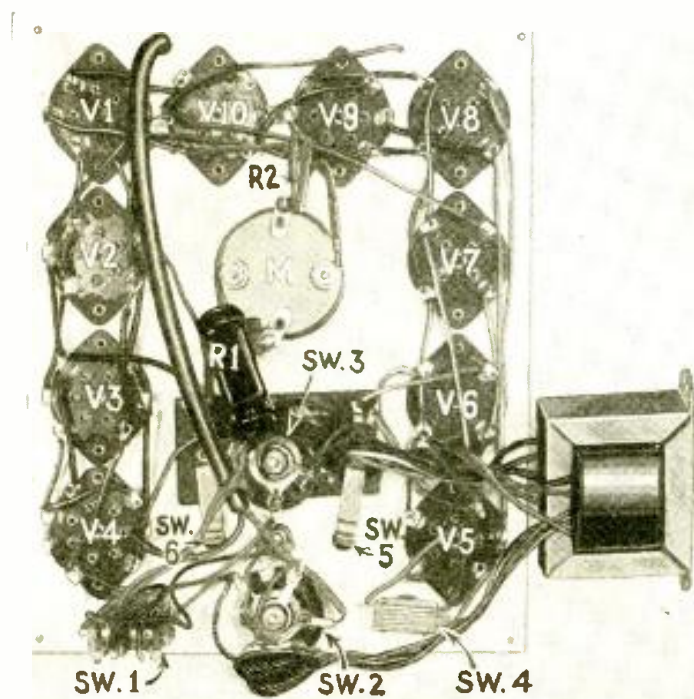

Fig. B

Rear view of the tester. The lettering corresponds to those given in Figs. 1 and 2. A very simple wiring job.

THE radio dealer and technician is in a dilemma, today, as to what to buy or to build for test equipment. Surely, the fact that there are at present very few people in the business who are actually showing a reasonable net profit should be a sufficient reason for proceeding with caution. Moreover, new tubes and circuits are appearing so frequently, that test equipment soon becomes obsolete and fails to earn the proper return on its investment.

Radio testing is divided into two distinct phases: the first comprises systems or circuits and their component parts; the second involves the tubes used in these circuits. Under existing circumstances, it is important, when buying costly test equipment, to make sure that sufficient provision is made for probable changes in the future. However, even though a large safety factor is provided, it is practically impossible to be sure that equipment purchased today will be satisfactory for the circuits and tubes of several years hence. Therefore, it is good common sense to buy the latest type of tester at the lowest price consistent with satisfactory results.

This line of reasoning applies to tube checkers to a greater extent than to most other test apparatus. The instrument to be described, known as the Dependable No. 301, is the solution to this problem. It is designed to provide a satisfactory and up-to-date tube checker for portable or for counter use. It should appeal to the Service Man and to the small radio dealer who is not justified in making an investment in a large, expensive dynamic type of tester, but who can, at a very nominal cost, assemble an instrument that will test all the new 6- and 7-prong tubes as well as the 4- and 5-prong types.

Rating Tubes

Tubes are rated from a standpoint of performance by several "characteristics." That characteristic of a tube which is most significant and which represents, in most cases, the key to the general performance of a tube is mutual conductance, or transconductance. This term may be defined as the change in plate current per unit change in grid potential. To establish accurately the mutual conductance of a tube requires a rather elaborate set-up of expensive apparatus, and even then the results would not necessarily be of much value to the average dealer or Service Man.

Description of Tester

A simple tester that will indicate relative, arbitrary transconductance values in tubes to be tested, when compared with good tubes, will indicate whether a given tube is good or bad. This is exactly what the Service Man wants to know, and he can readily determine it with the tester to be described. This checker has the advantage of a "short" test. A shorted tube may damage the instrument if tested in the ordinary manner. To guard against such a hazard, the tube is first tested with the "short-regular" switch, SW. 1 in Figs. 1, 2, A, and B, in the "short" position. *The pilot lamp will light if the tube is shorted.* If no short is

*Chief Engineer, Radio City Products Co.

indicated, proceed with the test, having the "short-regular" switch in the "regular" position.

As relative meter indications in these tests are of prime consideration, and as absolute values of current are of no importance, the circuit has been designed to give the largest possible scale deflections, and the meter dial is arbitrarily calibrated for simplicity in reading. The meter has a 30 division scale, and is designed to give large indices of relative mutual conductance values which are not crowded into the lower portion of the scale as is often the case with tube checkers.

Line voltages differ in various cities and sections throughout the country; in fact, there is sometimes a considerable difference in line voltage in various sections of the same city. If the tube tester has no provision for line voltage adjustment (and most low-priced instruments have none), the plate and filament voltages applied to the tube under test would vary correspondingly with any change in line voltage. The same tube would test differently at different line voltages and the readings would be "off" compared to the arbitrary relative values. To overcome this difficulty, the transformer PT is tapped for line voltages of 105, 115, and 125 volts, and is manipulated by means of a line voltage switch, Sw. 2. The plate and filament voltage will then be constant regardless of whether the line voltage is 105, 115, or 125 volts.

Another important advantage of the No. 301 tester is the specially lithographed panel, shown in Fig. A. The tube type-numbers appear in numerical order alongside the socket to be used, and results in simplicity and speed of operation. The corresponding position of the filament selector switch, Sw. 3, is also lithographed alongside the tube numbers, thus eliminating any guesswork as to the proper filament voltages to apply to a tube, and makes it unnecessary to refer to separate charts. This feature will be particularly appreciated if one has used any of the commercial testers on the market.

No adapters are necessary for testing the latest type 6- and 7-prong tubes. This feature will be appreciated by all radio men who have been troubled by the adapter problem. It is quite a relief to be able to test any type of tube without the trouble and expense of adapters. The unique advantage of this layout is, however, that, notwithstanding the features of ease of operation, speed, simplicity, satisfactory performance, and elimination of adapters, the cost of assembling the apparatus is much lower than that of the average tester not having these desirable features.

The combination portable and counter model No. 301 Dependable tester measures approximately 9 x 11 x 5 inches, (Continued on page 619)

FEATURES OF THIS TESTER

- (1) Indicates emission and mutual conductance
- (2) Tests all tubes without the use of adapters
- (3) Indicates all tubes with shorted elements
- (4) Simple and quick in operation, no calculation
- (5) Positive in action, no guesswork needed
- (6) May be fully constructed for about \$10.00
- (7) Large, readable scale deflections on meter

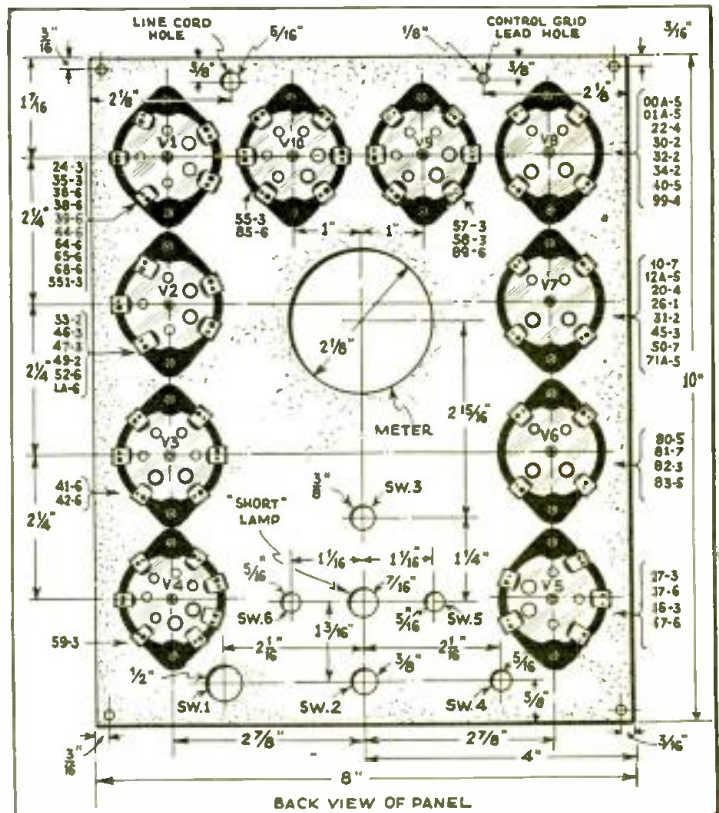

Fig. 2. Panel layout of the tester. Note that the sockets are reversed from that shown in Fig. A. This is because the panel is reversed when working on it.

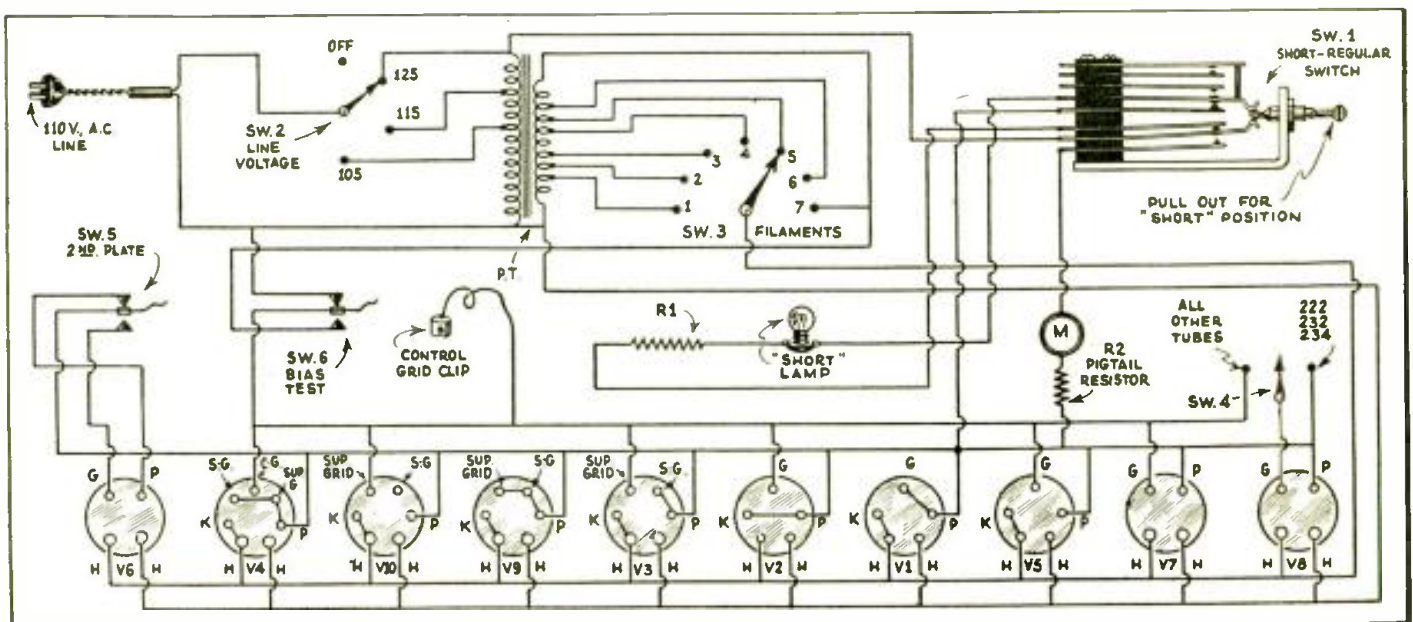

Fig. 1.

Complete schematic circuit of the tester. The jack switch Sw. 1 is shown connected when pulled out for the "short" position. Push it in for "regular" tests.

MAKING MONEY WITH AMPLIFIERS

Part Four of a series written especially for Service Men who want more business; the authors tell of the possibilities of mobile, portable and temporary installations, which will find increasing use with the approach of the Spring season.

HUBERT L. SHORTT
and FRANK LESTER*

WITH the approach of the Spring season, the wide awake Service Man with an eye toward increased business should start considering the possibilities of mobile, portable, and temporary public-address amplifiers. There are many prospects for amplifier service falling within these categories. Here are a few immediate suggestions: small carnivals, circuses and bazaars; patent medicine salesmen and other itinerants; local merchants and theatre owners who want street ballyhoo; and social, business and fraternal organizations, for meetings, dedications, etc.

A mobile amplifier is one that is capable of operation while being carried in a moving vehicle. This means it must be a battery operated outfit; that is, current must be supplied by the storage battery in the car. With the perfection of small, efficient "B" power units of both the dynamotor and vibrating interrupter types, heavy, troublesome "B" batteries are eliminated and the amplifier always works at maximum efficiency.

Mobile amplifiers are best suited for use in trucks or private cars which run slowly along the streets while an announcer—usually the driver "doubling in brass"—tells about the special sale or other event sponsored by the advertiser. A phonograph turntable, with a plentiful supply of records, is an important accessory, as continuous talking soon becomes as boring to listeners as to the man doing the talking.

Some merchants purchase such amplifiers outright and install them permanently in specially fitted decorated trucks. If a dealer or Service Man can make a sale like this he should consider himself lucky. However, these trucks, even in large cities, soon lose their novelty appeal as people become accustomed to them, and then the store owner finds himself with a "white elephant" on his hands. It is perhaps better business policy for the Service Men to rent the merchant an amplifier for a couple of weeks, asking a good price, and, at the same time explaining that too much ballyhoo in the streets will defeat its own purpose. The merchant will undoubtedly appreciate the suggestion and will be much more friendly to other suggestions in the future.

Many Service Men fit up their own cars or trucks and rent them out as complete units. This involves some investment, and need not be attempted unless a spare car can be purchased at a bargain price.

A portable amplifier is similar to a mobile amplifier except that it is not

operated in motion. Of course any "mobile" may be used for "portable" service, but the reverse is not true. A portable is carried to the scene of action, set up, and then repacked for transportation after the event is over. Portables may thus be either battery or A. C. operated. In the country, where many meetings, exhibitions, fairs, etc., are

held in open fields or under tents, and an amplifier is desired for "spieling," the entire apparatus may be left in a car if it can be parked in a safe spot and is needed only for a day. If the event is to last several days, the amplifier should be of the kind that operates entirely on a six-volt storage battery. The Service Man handling the job can thus drive around once a day with a fresh, fully charged battery and make any necessary inspections. The power efficiency of these amplifiers has been improved to the point where they draw only about eight amperes, which is a convenient and altogether reasonable load for an 80- or 100-ampere-hour battery.

Physical considerations, such as the protection of the microphones, loudspeakers and amplifiers proper, must not be overlooked. Keep all apparatus well elevated above the grass line, and supply oilcloth or other protective covers for the mikes. Early morning dew and fog can raise plenty of trouble if such protection is not furnished.

One of the most profitable sources of income for Service Men is the renting of small portable amplifiers, of the A.C. type, for meetings, lectures, conventions and similar affairs sponsored by social, business, fraternal, political and military organizations. Either the organizations themselves or the owners of the meeting place should be approached on the subject. The latter are perhaps the more dependable customers, as they can attract and hold patronage by including the amplifier service in the rental fee for the hall. The acoustics of many old fashioned town halls, lodge rooms and "opera houses" is notoriously bad, and a P. A. amplifier with a healthy "sock" will do a lot toward overcoming this unfortunate condition.

Women's clubs are especially good prospects, as few women can fill even an ordinary meeting room with their natural voices, particularly when working against the undercurrent of conversation that seems to pervade most feminine gatherings. As recommended in a previous article of this series, the Service Man should always carry a microphone with him when making calls on club presidents; women in particular are fascinated by the instrument and become more suscepti-



Mr. Shortt demonstrating the portability of the Lafayette portable amplifier outfit.



Close up of the Lafayette Dual Speaker Portable Amplifier. Along the left side are (top to bottom) mike coupling transformer, gain control, and mike batteries.

*Wholesale Radio Service Co., Inc.

bie to sales talk, when they are allowed to handle it.

Compactness, minimum of weight, and dependable output are primary requisites of an amplifier for this class of service. A typical outfit that is proving highly satisfactory is the new Lafayette Dual Speaker Portable A.C. Public Address Amplifier, illustrated on these pages. It was designed especially for quick

set-up and repacking, is light enough for one man to carry up a flight of stairs without breaking an arm, and is loud enough to gain the respect of crowded meetings. It can be set up, ready for service, in less than five minutes, no tools being required for the job.

A carrying case 15 inches square and 10 inches deep contains a complete two-stage amplifier, microphone batteries, mike coupling transformer, gain control and speaker outlet sockets. The two removable sides of the case each hold an 8-inch dynamic speaker, equipped with a 15 foot flexible connecting cord. The speaker boards are fitted with hinged feet, by means of which the units are placed upright. When the speakers are in the case, the cones are protected on the outside by removable covers.

The amplifier proper is a compact unit comprising a type 57 tube resistance capacity coupled into a 59, with an 80 rectifier, connected as shown in the accompanying schematic diagram. The gain control is a 500,000-ohm potentiometer connected across the secondary of the microphone coupling transformer. In its minimum position, it shuts off the mike battery, which consists of two No. 6 dry cells in a box next to the amplifier. These batteries justify their weight because they are cheap, simple, reliable, and quiet as only batteries can be quiet. The mike transformer, mounted above the batteries, is iron shielded to prevent pick-up and coupling effects.

The long horizontal illustration shows this P.A. outfit set up for actual service on the stage of a small auditorium. The box is placed in the center of the stage, with the speakers off to the right and left. The amplifier is shown in full view in this picture, but, of course, it may readily be concealed behind the speaker's table or stand. A full height microphone stand is shown; a lapel mike may be used just as well. The chairman of the meeting may be instructed in the use of the volume control, which is very simple.

The use of two speakers, instead of the single speaker usually found in portable P.A. outfits has been found to be highly advantageous in breaking up "dead spots" and in securing the best sound distribution. Every hall or meeting room encountered in the authors' experience has required different treatment in re-

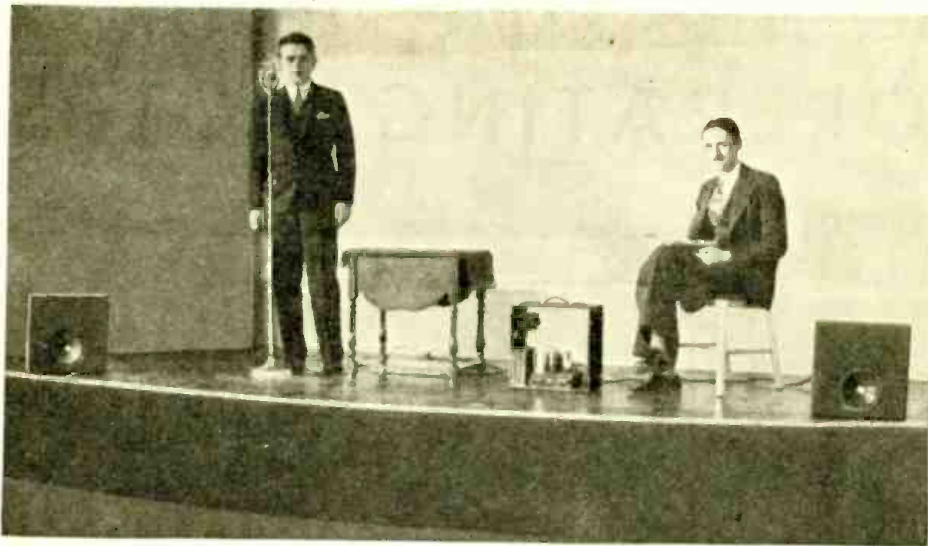

The Lafayette Dual Speaker Amplifier set up on the stage of the Wholesale Radio auditorium to show how the speakers dismount from the carrying case. Mr. Shortt is at the mike; Mr. Lester is seated.

gard to speaker placement.

Incidental Suggestions

In renting out amplifiers and associated equipment, insist on a healthy deposit as your guarantee for safe return of your material. No one will object to this, as practically every renting agency works on this basis. Of course, if you go out with the outfit yourself and handle it personally throughout the renting peri-

od, this precaution is not necessary. Never fail to carry a few spare tubes, as you can never tell when one will pass out. Also carry a few business cards and don't be afraid to hand them out freely.

Getting New "Leads"

Here are some additional prospects for mobile or portable public-address amplifiers, not previously mentioned: rodeos, homecomings of local celebrities, bridge openings, dedication ceremonies, field meets, charity bazaars, rallies, boat races, lawn fetes, street dances, real estate auctions, ski tournaments, etc. How do you find out about these events? Very simple; just read all your local newspapers from the first column to the last, cutting out every item that sounds like business. The number of "leads" that you can pick up in this way is astonishing.

Another good contact to make is with theatrical booking agencies. If there are no such agencies in your own city, buy a copy of "Variety" at the railroad station new-stand (this is the Bible of the theatrical profession), look up agencies in the nearest large cities, and send them letters or circulars describing the P.A. services you have to offer. Booking agencies handle all kinds of entertainers from midget troupes to circuses, and very frequently make use of P.A. systems for ballyhoo purposes or as part of actual "acts."

Advertising Helps

It is necessary in most cases to have some sort of printed matter available for distribution among prospects. This should describe in a general—not technical—way, what apparatus you have, how you transport and set it up at a minimum of bother to the customer, what previous jobs you have handled, etc. It is very desirable to include illustrations showing your set-ups at recent events, and to reprint testimonial letters from satisfied clients. Most firms are glad to write such letters on request, particularly if they are told

they will be used in circulars or advertisements which will give them free publicity. You can readily obtain clear snapshots, suitable for half-tone reproduction, with an ordinary hand camera. The authors will be glad to correspond with Service Men on P.A. problems.

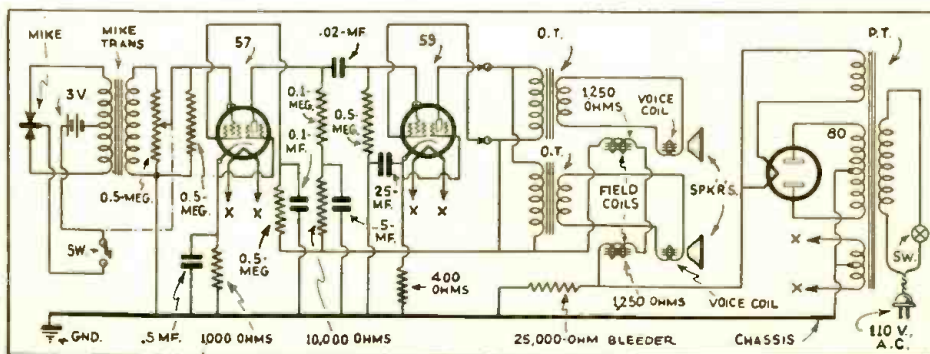

Schematic circuit of the amplifier discussed by the authors.

THE ANALYSIS OF RADIO RECEIVER SYMPTOMS OPERATING NOTES

A. R. QUACKENBUSH

IN spite of the fact that many of the first A.C. Sparton receivers have passed their fourth year of life, we find that in most instances the owners continue to hang on to them, probably because of the fact that the set cost about \$375 and, also, because they still sound good owing to the excellent magnetic speaker installation found in these receivers. You are more likely to get a call to service a receiver of this age than a newer set, and, with warmer weather coming on, we find that the condenser blocks in these receivers are more apt to break down. A large number of calls for service on these sets, last summer, were caused by condenser replacements, and fortunately, they came during the hotter months when most other servicing was slow.

Sparton 62, 63 and A.C.7 Sets

All of us have had jobs on older sets which were not designed with the service idea in mind, and we found that much time was lost in tracing loose, unmarked and un-coded leads that were not connected with any definite plan in mind. In such receivers we usually find the chassis divided into three different sections, and have to waste time removing and replacing the set as well as repairing it. However, with a proper understanding of the layout, and knowledge of which leads are which, a lot of time and trouble can be saved, making preliminary testing in the home easier and surer.

Figure 1 is a schematic diagram of the models 62, 63 and A.C.7 Sparton receivers using Kellogg heater-type tubes with overhead connections in all sockets except in the output stage, where two 71's or Sparton type 82, 82A or 83 tubes may be used. These latter tubes are connected in parallel, not in push-pull. A BH Raytheon is used as the rectifier.

Preliminary Testing

Having been called upon to service a set of this kind, you will, of course, go through your ordinary procedure of preliminary testing with an analyzer. The upper front door of the set pulls down and exposes the off-on switch on the left, and is simply pulled out to turn the set on; the vol-

WHAT THIS DEPARTMENT IS FOR

It is conducted especially for the professional Service Man. In it will be found the most unusual troubles encountered in radio service work, written, in a practical manner, by Service Men for you.

Have you, as a professional man, encountered any unusual or interesting Service Kink that may help your fellow workers? If so, let us have them. They will be paid for, upon publication, at regular space rates.

ume control is on the right, and the tuning control is in the center. The top cover raises as on many battery sets. The three heater tubes in the front row as you stand in front of the set are the R. F. stages; the heater at the right, in the second row, is the detector; and the other heater in this row is the first audio-frequency tube, just as is shown in the schematic circuit.

If this is the first of these types of sets you are checking, it would be advisable to check first the 71's in the output stage, as these are standard tubes. You will have no trouble doing this, and it will give you a little time to look around and get acquainted with the set. If type 82, 82A, or 83 tubes are in these sockets, they may be checked in the same manner as the 71's, and they will give about the same readings. In a few rare instances you may run across some 81's, which are 3-volt side-pin heater tubes, which are connected to the filament supply for the rest of the tubes.

Checking the Heater Tubes

If there are many sets of this type in your locality, it will probably pay you to prepare some test leads for the Kellogg overhead tubes and the Cardon side-pin tubes. Figure 2A shows how to make them. A top from an old Kellogg tube may be used. Leads from the top may be brought out to a couple of small battery clips, although a base from a side-pin tube could be used just as well; it is advisable to break off the prongs so that there is no danger of shorts. The leads must be of heavy wire and not longer than the cord in your analyzer. Two or three lengths of old loop aerial wire, twisted or braided together as one lead, using four or six lengths altogether, make fine flexible leads.

A good 401 tube in either the Kellogg or Cardon types should show 4 to 6 ma. of plate current. The best way to test these heater tubes is to check the plate voltages first by simply removing the tubes and placing your analyzer plug, using the four-prong adapter, into the sockets one after another, in turn, simply leaving each tube hanging

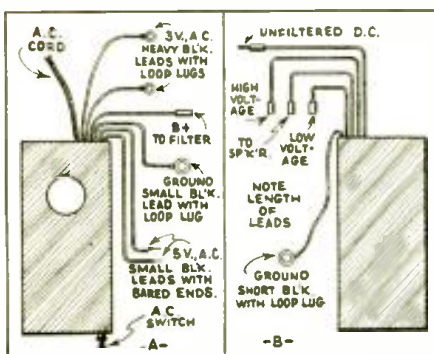
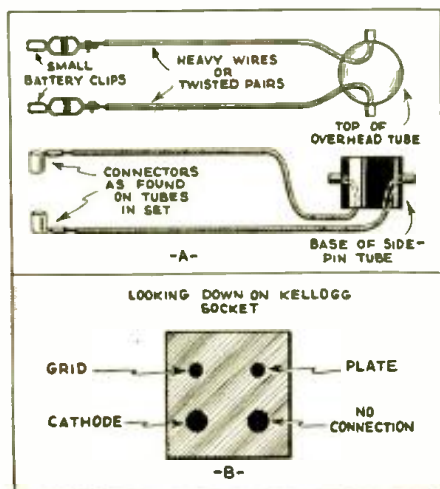
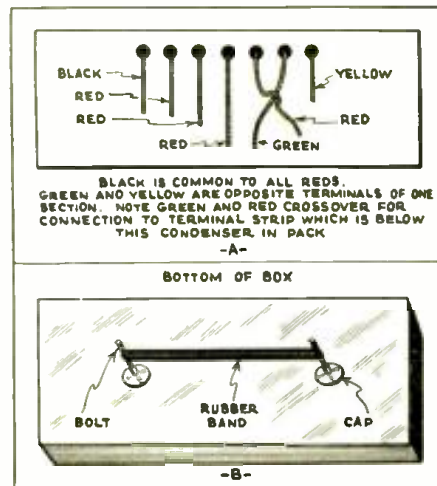

Fig. 2, left
At A, making the special test leads; at B, socket connections of the Kellogg tubes.

Fig. 3, above
At A, the power transformer box; at B, the right-hand box in the power unit.



BLACK IS COMMON TO ALL REDS. GREEN AND YELLOW ARE OPPOSITE TERMINALS OF ONE SECTION. NOTE GREEN AND RED CROSSOVER FOR CONNECTION TO TERMINAL STRIP WHICH IS BELOW THIS CONDENSER IN PACK

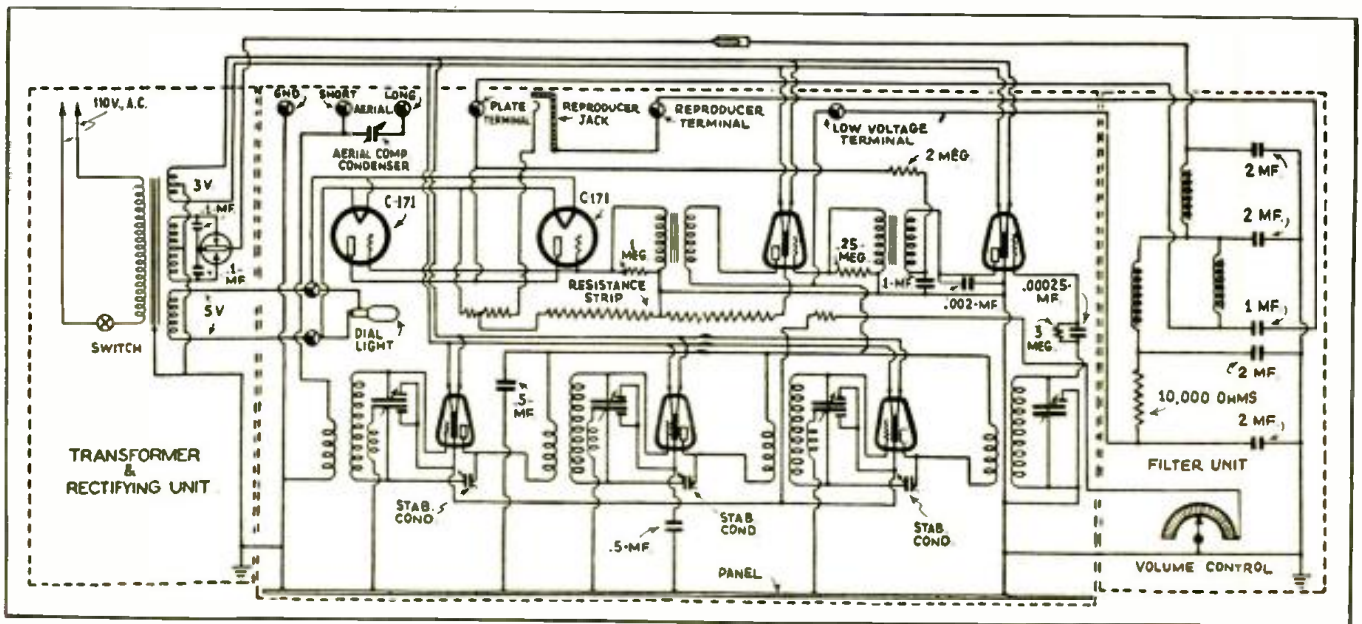

Fig. 1
Schematic circuit of the models 62, 63, and A.C.7 Sparton receivers, discussed.

by the heater leads. Plate voltage readings may be obtained without the tube in the analyzer. Have only one tube out of a socket at a time, so that you do not unload the plate supply too greatly. Then, if you want to check the tubes, place your analyzer plug into one of the R. F. sockets, get your adapter ready, and check the plate current of all tubes, one after another, from this same socket. No A.C. filament voltage will register as there are no connections into your analyzer from the filament circuit.

Figure 2B shows the socket connections for these tubes. The plate and grid connections are the same as on any standard four-prong socket. If you check the filament voltage, be sure that short heavy leads are used in order to avoid excessive voltage drop. If you have not made up the adapter as shown in Fig. 2A, you may get a fair check of each tube by having your analyzer plugged into one of the sockets and quickly removing a tube from the heater leads and plugging it into the analyzer, noting the plate current before the tube has had much time to cool.

Layout of Parts

Looking at the set from the front, the left-hand box houses the power transformer, the BH rectifier, and the buffer condenser, just as shown in the schematic. Figure 3A shows the leads from this box. The 3-volt A.C. leads go to the strip on the back of the set for the heater leads. The 5-volt A.C. leads are placed under the two push-down posts at about the middle of the left-hand side of the chassis proper. The short black lead with the lug goes to the bolt projecting up on the chassis panel, on the lower left-hand corner. The long lead with the female connector carries the unfiltered output from the BH rectifier. An A.C. switch, which is bolted onto the front panel, is brought out of the front of this box.

The long black lead from the box carrying the unfiltered "B" current is connected to the right-hand box, as shown in Fig. 3B, by the other half of this connector. Note that there is no filter choke or condenser in this circuit until we get into the right-hand box. Knowledge of this point simplifies testing, as will be explained. The three long rubber covered leads connecting to the back of the set furnish the filtered "B" current to the chassis and connect the speaker filter and choke to the chassis circuit, as shown in the schematic. These three leads are cut different lengths, so that by noting their length, they may easily be placed back in their correct posts.

Common Troubles

By far the most common trouble in these sets is lack of plate voltage in all stages. This is usually due to one of two things, and may be quickly traced. Run a screw driver between the chassis and the right-hand box, so that all the

leads going to it may be lifted so you can get at them. Select the long lead running between the two boxes, disconnect the connector, and then click it back again. A spark will show that current is being supplied from the BH rectifier. No spark would point to a defective BH, transformer trouble, or a broken down buffer condenser.

The buffer condenser is the most likely cause of the trouble. The original buffer condenser is a small round one, impregnated only with paraffin. (If a large red-colored condenser is found instead, it is a Sparton replacement and the job has been previously repaired.) It is advisable to replace the entire buffer condenser with two .1-mf. sections if one half is found shorted.

If a spark is obtained, with no plate voltage, a section of the filter block in the right-hand box is most likely defective. Turn off the set and remove the three long leads to the back of the set, those coming from the right-hand box. With a continuity tester, test between the male end of the connector, located between these boxes, and ground. A good ground connection may be had at the ground lead from this box. A low resistance reading tends to show that one of the three 2 mf. sections ahead of the 10,000-ohm resistor is bad. The last 2 mf. section may be checked by continuity between the shortest of the three rubber-covered leads and ground. The 1 mf. section may be checked by continuity between the other two leads themselves, no connection to ground. This is the speaker output condenser, and should it go bad, reduced volume, hum, and distortion will be present. Occasionally, this condenser will be found to be leaky and not show up on an ordinary continuity test, but may be detected by the above symptoms. Figure 4A shows the location of the leads to the condenser block, which can be seen immediately when removing the cover from this box.

Thus, with our knowledge of the location of the leads, and what is in the boxes, it is quite easy to make a fairly satisfactory check of the two boxes without removing them, and then, if the trouble is found to be in one or the other, it may be quickly removed without disturbing the rest of the set. Little trouble is found in the chassis proper. Occasionally the resistance strip, which is a long, wide, wire-wound strip, becomes open, or one of the three small tubular condensers, which are easily visible when examining the underside of the chassis, will break down.

Removing the Chassis

About half way down the back of the set will be found a board which may be removed either by turning wing nuts or removing wood screws. This board allows us to get at the bolts and nuts holding the chassis in place. To remove the right-hand box, it is simply necessary to disconnect

(Continued on page 624)

CROSLY ROAMIO AUTOMOTIVE T.R.F. RECEIVER MODELS 90, 91 AND 92

(The T.R.F. series of Crosley Roamio sets; Radio Service Data Sheet No. 88 describes the superheterodyne series.)

Model 90

Average operating potentials are given below. These values are measured with the reproducer connected and the tubes in place. For plate and grid voltages, use a high-resistance meter: measure from tube element to negative filament.

Tube Type	Fil. Volts	C.-G. Volts	S.-G. Volts	Plate Volts
V1	2.0	2.5	90	135
V2	2.0	2.5	90	135
V3	2.0	3.0	---	22.5
V4	4.7	12	---	135
V5	4.7	12	---	135

The A.V.C. potential is derived as the drop across R2. With increased signal, more current flows through the plate circuit of the combination detector and A.V.C. tube, V3, increasing the bias voltage applied to the control-grids of V1 and V2. This results in a reduction of the R.F. amplification, and thus maintains constant the A.F. output determined by the setting of R1.

Battery D supplies plate potential for V3. The negative "B" and positive "C" lead returns to the center-tap of two 25 ohm resistors,

to secure the same plate potentials regardless of whether the car-battery positive or negative terminal is grounded.

Model 91

Average operating potentials are given in the tabulation below. Measure, with a high-resistance meter, to the negative filament contact.

Tube Type	Fil. Volts	C.-G. Volts	S.-G. Volts	Plate Volts
V1	2.0	1.5	100	170
V2	2.0	1.5	100	170
V3	2.0	2.5	7.5	45
V4	4.7	10*	---	170
V5	4.7	10*	---	170

*With volume control "off."

If a signal of sufficient strength is received to cause current to flow in the grid circuit of V3 (biased by R6), the resultant drop across R2 decreases the amplification of V1, V2. Resistors R3, R4, R5 are R.F. filters.

Manual volume control R1 determines the A.F. input to the control-grid of A.F. amplifier V4.

Model 92

Operating potentials appear in the table.

Tube Type	Fil. Volts	C.-G. Volts	S.-G. Volts	Plate Volts
V1	5.9	3	75	170
V2	5.9	3	40	170
V3	5.9	3	40	45
V4	5.9	20	---	170
V5	4.7	40	---	170
V6	5.9	---	---	3

The circuit is adjusted for zero current flow in the circuit of A.V.C. tube V6, with normal signal input; at the same time resistor R3 establishes the normal bias required by the control-grids of V1, V2. Now, an incoming signal of increased strength causes diode V6, in conjunction with load-resistor R2, to develop across R2 an increased D.C. negative potential which reduces the amplification of V1, V2. Resistors R4, R5 are R.F. filters.

The A.F. input to the first-A.F. tube, V4, is determined by the setting of the manual volume control, R1.

Manual volume control resistor R1 has a value of 0.3-meg. Since Crosley Service Bulletin No. A8 does not include the tube operating voltages for the model 92, estimated values are given.

At the present time there are no Roamio models 93 or 94 receivers.

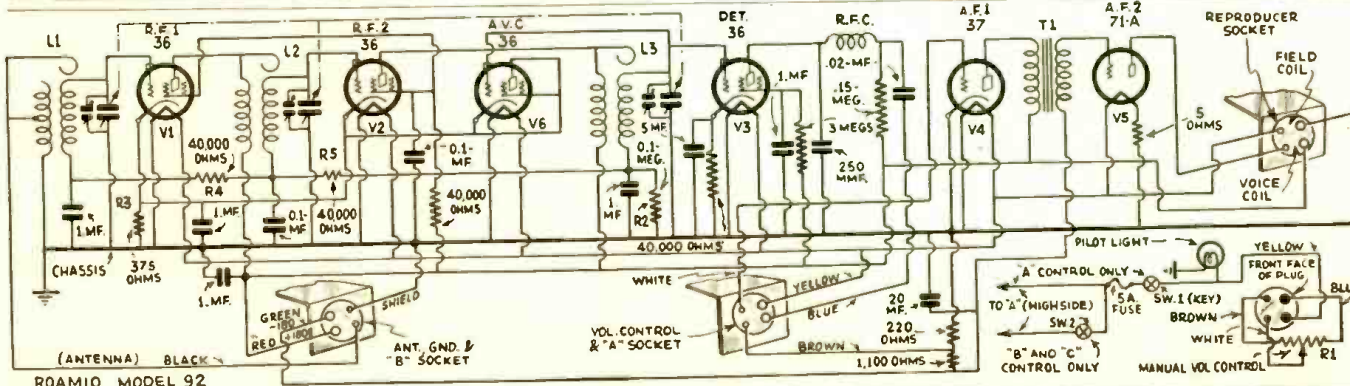
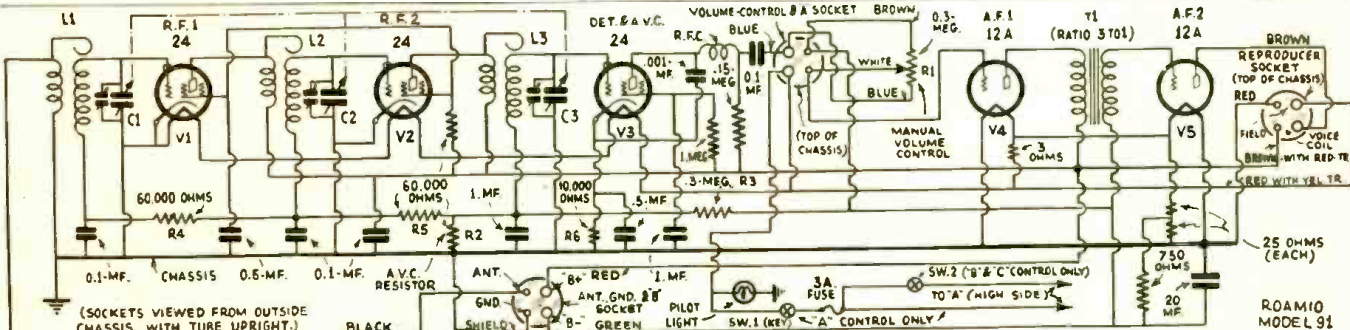
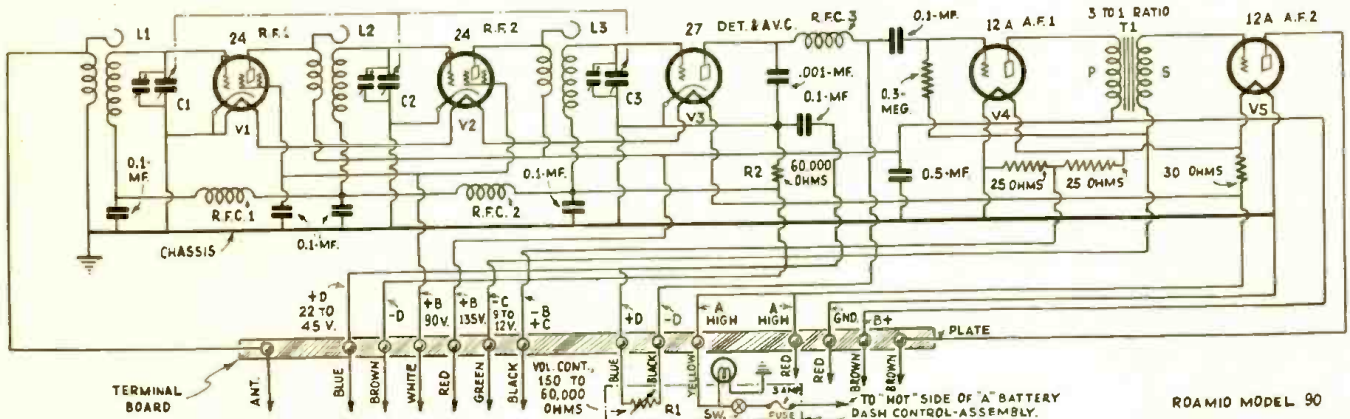

READERS' DEPARTMENT

A department in which the reader may convey his thoughts to other readers. Included in this department are letters, kinks, short cuts, and experiments. Send in your ideas.

SHOWMANSHIP IN RADIO SERVICE

Editor, RADIO-CRAFT:

Showmanship is a most important factor in radio servicing, yet most Service Men overlook it entirely. An efficient-looking shop suggests to prospective customers the importance of having the job done right and impresses them with your ability to turn out good work. Such a shop tends to instill confidence in the customer, and makes it unnecessary to cut prices to get work.

Figures A and 1 shows how a shop display may be made that will convince customers that their radio is in competent hands.

At any secondhand furniture store a used library table may be purchased for about \$2.50; it makes an ideal workbench. In the same store a chest of drawers may be had for about \$1.50; it makes a fine parts cabinet, and its top will serve as a spare workbench when the regular one is crowded.

The two square instruments hanging above the workbench are home-made oscillators built into the cases of old style Sterling tube checkers, which were purchased for fifty cents each. A discarded Majestic "B" eliminator (on the shelf of the workbench), furnishes high voltage for condenser tests. Service manuals, and manufacturer's data in neat looseleaf binders are kept in full view, together with text books on radio theory and service. The wall behind the workbench is literally papered with blueprint schematic diagrams of radio receivers.

The main testing equipment may be your portable test kit. In the photograph is a Weston model 547 set analyzer which is cabled to the bench control-panel. It may be quickly detached and taken on field calls, thus eliminating the need for duplicate equipment. In the schematic diagram is shown how the test kit is cabled to the control panel.

Sundry other meters are mounted on the bench back board. The instrument resting upon the parts cabinet is a Day-Rad tube checker. A smaller instrument, a Weston model 533, not shown in the photo, is carried on field calls along with the model 547 analyzer. Field equipment and tubes are carried in a sturdy fiber case (shown in front of the parts cabinet), which

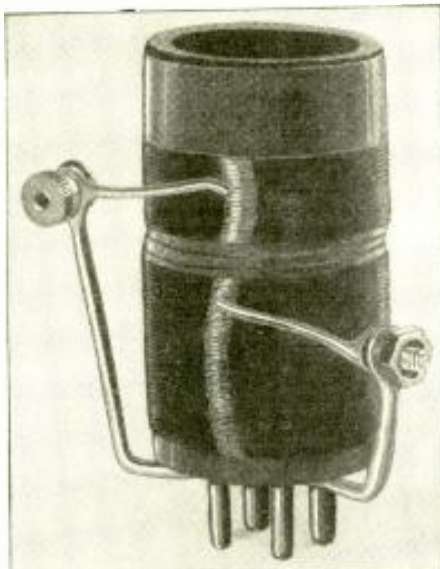

Fig. B
Don't guess: use this scheme.



Fig. A
The very interesting service bench of Mr. Freed.

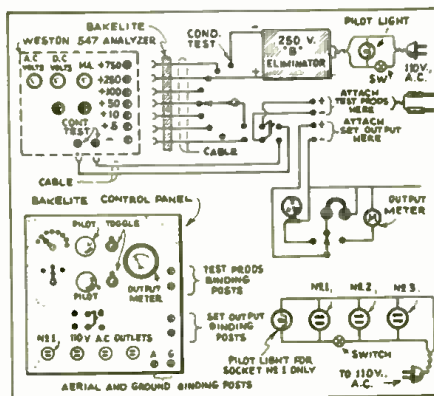

Fig. 1
Layout of the service bench illustrated in Fig. A.

was purchased secondhand for \$2.00. Across the sides of this case are printed boldly our firm name and address.

It is equally important that an efficient appearance be made in the customer's home if you expect to get the job at a price that will show you a profit, so don't be bashful. Display all your equipment while the customer looks on; he is highly interested in watching the meter needles fly back and forth (even if he doesn't know what it all means). Take an extra minute or so to explain simply what you are doing. By so doing you will impress him with the fact that you know your business thoroughly, that you are not merely guessing. Then he will be less likely to attempt to chisel you out of your profit.

Incidentally, be sure that your personal appearance is professional. Service Men who dress like day laborers generally, get paid accordingly.

To use the portable analyzer with the bench control-panel, mount the model 547 instrument vertically at the rear of and about 18 ins. above the workbench. Connect the voltmeter binding posts by means of a bakelite strip and cable to their respective contacts on a multi-point switch mounted on the panel.

To measure voltages, set the Weston switch No. 1 to switch No. 2, and switch No. 2 to V.M.B.P. Throw the panel double-throw switch to the left and set the panel multi-point switch to the desired meter range, and then apply the test prods. This whole procedure takes about two seconds to perform.

To make continuity tests, set the Weston switch No. 1 to switch No. 2, and switch No. 2 to Cont. Test. Throw the D.P.D.T. panel switch to the right and again apply the test prods.

To test condensers, set Weston switch No. 1 to switch No. 2, set switch No. 2 to V.M.B.P., and set the panel multi-point switch to Cond. Test. Now, when the "B" eliminator is turned on and the test prods applied to condenser, the Weston voltmeter will swing to 250 V. and then drop back sharply to zero if the condenser is perfect. (The speed with which the needle moves is a rough indication of the capacity of the condenser.) The pilot light will remind you to turn off the eliminator when the

(Continued on page 633)

RADIO-CRAFT'S INFORMATION BUREAU

SPECIAL NOTICE TO CORRESPONDENTS: Ask as many questions as you like, but please observe these rules:

Furnish sufficient information, and draw a careful diagram when needed, to explain your meaning; use only one side of the paper. List each question.

Those questions which are found to represent the greatest general interest will be published here, to the extent that space permits. At least five weeks must elapse between the receipt of a question

and the appearance of its answer here.

Replies, magazines, etc., cannot be sent C. O. D. Inquiries can be answered by mail only when accompanied by 25 cents (stamps) for each separate question.

Other inquiries should be marked "For Publication," to avoid misunderstanding.

"ULTRA MODERN SUPER"

(189) John Rosano, Stege, Calif.

(Q.1) I am just learning the radio game, and many things are not yet clear to me. For instance, I do not understand the drawing of the type 58 tube in the article on the "Ultra Modern Super" in the October, 1932, issue of RADIO-CRAFT. There are only 6 leads, and there should be 7; the suppressor-grid lead is missing. I would also like to know which lead on the type 55 tube is the cap.

(A.1) The connections of the type 58 tube are indicated in "RADIO-CRAFT'S Tube Table" which appeared in the July, 1932 issue of RADIO-CRAFT. The type 55 tube cap connection is the control-grid of the triode section of the tube.

Mr. Charles J. Romer, New York City.

(Q.2) I am very much interested in building the "Ultra Modern Super" radio receiver described by Clifford E. Denton. I have a number of parts just suitable for that purpose, and I would be very grateful if you would clear up some of the smaller details. In reference to the column giving the List of Parts, I would like to know if that four-gang tuning condenser is the common type, having, as part of itself, a little trimming condenser for each variable condenser? If so, then what is referred to by C3A? Where do you place the small variable condensers, C4, C6 to C11? You give in your List of Parts the following: 6 Acratest tubular condensers, .1-mf., C12, C14, C16, C17, C26; where is the sixth? Where do you place the tubular electrolytic condenser type 6650, 50 volts, 10 mf., C18?

I do not understand the constructional details of the coils. In Fig. 2A, you show the band-pass coil, and I note that there are five coils, yet you state that there are three, both in the schematic diagram and under the heading of coil data. How are these coils (meaning all the coils in the set) hooked up?

(A.2) Each tuning condenser has its own small trimmer mounted on the tuning condenser proper. One of these is C3A. The main tuning condensers are C1, C2, C3, and C5. Units C4, C6, C8, C9, and C10 are small trimmer condensers connected as shown in the circuit. Those from C6 to C10 inclusive are part of the I.F. transformers. C4 is a separate unit, the value for which is given in the List of Parts. The sixth .1-mf. fixed condenser is C15, whose connections are clearly indicated in the circuit. Condenser C18 is placed directly across the two terminals of resistor R11, as shown in Fig. 1 of the article. It is only a small unit, perhaps 2 ins. long x 1/2- to 3/4-in. in dia. The coil data given in the article is correct, but please disregard the lengths of each winding. Merely wind a specific number of turns with the specified wire.

Referring to Fig. 2A in the article, there are only three coils present: the antenna coil, (which is clearly labeled as such) and the two band-pass coils. Now, the point to remember is, that when winding one of the band-pass coils, each of which contain 126 T. No. 33 enamelled wire, wind 40 T. close together, but begin the 41st turn approximately 3/32-in. away, and then complete the remaining turns. In other words, this single coil has two sections, one consisting of 40 turns and the other of 86 turns. The same idea is followed in winding the other coils.

Please bear in mind one point that was an error and that is, there are two R14's shown in the diagram, one of them, the value of which is given in the List of Parts, is connected to the center-tap of the Y filament winding while the other one, shown connected to Sw.1, should have a value of about 40,000 ohms.

The following additional information is furnished for the guidance of constructors who may find the information of value.

With reference to Fig. B, shown on page 203, the coil marked L4 should have been marked L7, since L4 is the small R.F. choke located immediately to the right of the real L7. Coil L4 is shown directly above the wording "DET. COIL."

The size wire with which the coils are wound should be No. 33 enamelled instead of the No. 30 enamelled described in the text.

If the coils are purchased, then one change should be made in the manufactured unit: an examination of the manufactured antenna coil will show that one end of L1, one end of L2, and one end of L3 all connect together. This connection is wrong. As the diagram shows, only coils L1 and L2 have terminals connected together. In the manufactured unit, therefore, it is necessary to disconnect that terminal of L3 which connects to both L1 and L2, and bring it out to a separate post, connecting it to

positive side. The filter choke and the field coil of the dynamic reproducer are in the grounded side of the power supply; these inductances are equally as effective in the negative side as it would be in the positive side, for filter purposes.

The coils are space-wound, which accounts for coils of different sizes taking the same winding space.

HOME RECORDING—WEBSTER P. A. AMPLIFIER

(190) Edward Mendelson, Brooklyn, N. Y.

(Q.1) I recently purchased a Patent No. 171 Recordovox, with control-box and weights. The control-box is not the same one as appears on page 42 of the RADIO-CRAFT Library Book No. 10, entitled, "Home Recording and All About It." I am using a Green Flyer 2-speed motor with a 12-in. turntable; I am also using a Universal single-button "handi-mike." I get wonderful results in recording radio programs but in recording music, using the microphone, I get very poor results, which I attribute to the microphone.

I own a music studio where I teach saxophone and clarinet, and I wish to record these instruments, later on extending this to recording bands. My technical knowledge is rather limited.

I use my Colonial 32 as an amplifier. This set incorporates a type 27 detector tube and two type 45 power tubes, and I use RCA Victor black, pre-grooved records and home recording needles.

I want to have some sort of a control box with an input stage with some sort of meter on it. Also, if possible, a level indicator.

What sort of microphone, sensitive or standard, and what kind of control box should I get? What is the approximate gain of my amplifier?

(A.1) If you require a very high grade of audio output, it will be necessary for you to secure a condenser microphone with an associated amplifier. If you do not care so much for quality but still desire good reproduction, then you might use at least a double-button carbon microphone.

Control box designs of various types, and also complete construction data on level indicators, have appeared in the RADIO-CRAFT articles on home recording.

The gain of your amplifier is approximately 60 db. which should be about sufficient for your purpose. We do not suggest any changes in the present arrangement inasmuch as you are bound to run into difficulty, due to the complications which would be sure to arise. However, if you care to spend the money, it might be well for you at least, to secure a separate amplifier, to be used for the recording system alone. This will result in increased stability and operation, which is entirely independent of your radio.

The usual run of needles for home recording do not give very good reproduction. In most cases, a decided lack of the higher notes are noticed and therefore these "soft" needles cannot be satisfactorily used for professional or semi-professional work. A high grade of needle of the sapphire type should be suitable for your purpose.

(Q.2) How is it possible to use tubes of only one type for a power amplifier? An example is the Webster Model B-112 Mobile D.C. Public

(Continued on page 623)

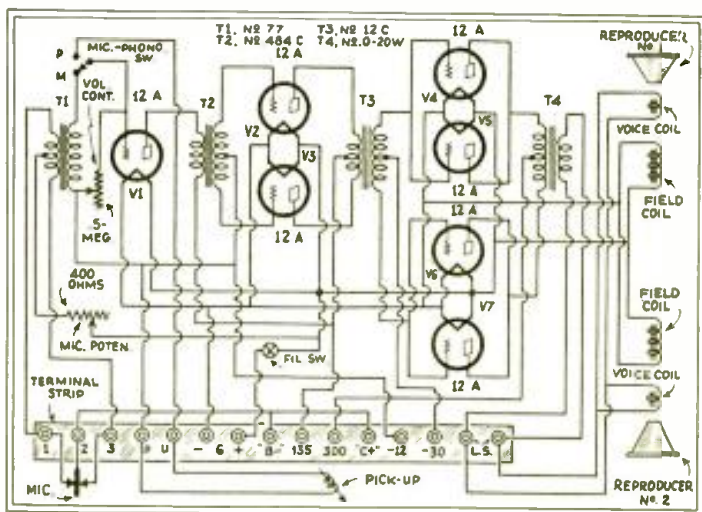

Fig. Q.190. Schematic circuit of the Webster Model B-112 mobile D.C. power amplifier.

C26 and R3, as shown in the diagram. The coil L6 has 26 turns of No. 33 enamelled wire. If the receiver motorboats after completion, insert an 85 millihenry choke in series with that side of resistor R7 which goes to the secondary of I.F.T.3.

(Q.3) Howard W. Minard, Owen Sound, Ontario.

Referring to the article concerning the "Ultra Modern Super" which appeared in the October, 1932, issue of RADIO-CRAFT, I believe that I have found some errors in the schematic circuit. First, the plates of all the tubes are connected to the ground filter system.

Also, in the drawings of the coils, the 80-turn grid coil, on the detector-oscillator-tickler form, is shown with a space of 1 1/2 in. Isn't there any difference between the spacing of these coils?

(A.3) You state that the plates of all the tubes are connected to the ground of the filter system. A closer check on the wiring will show that this is not the case, though. The plates of the tubes are connected to the filament of the 80 rectifier tube, which is the high voltage or

Radio's *Greatest*

The most
Complete Directory of Radio Circuit Diagrams—
in ONE VOLUME of over 2,300 Pages
with Extra Heavy Cover—Looseleaf Bound

Buy this Big Volume on our *New*

DEFERRED PAYMENT PLAN

Here are two of the most surprising announcements that we have ever made to the radio trade and we know that it is such good news that every radio man will be greatly enthused.

FIRST—that the three editions of the OFFICIAL RADIO SERVICE MANUALS have now been combined into one big volume of over 2,300 pages.

SECOND—that this new single volume of consolidated radio circuit diagrams and complete radio servicing course can be bought on a deferred payment plan—and at a big saving for you.

It is needless to say how valuable the OFFICIAL RADIO SERVICE MANUALS have been to members in every branch of the Radio Industry, and how many thousands of each edition have been sold to manufacturers, jobbers, dealers, Service Men and experimenters. But we must emphasize this one fact: Service Men now realize that they are tremendously handicapped without the full set of Gernsback Manuals. So much so, that those who have purchased only one or two volumes, are NOW ORDERING THE MISSING BOOKS. They want their files to be complete.

The complete book gives you a volume of over 2,300 pages with over 5,500 diagrams, charts and photos. There are absolutely no pages or illustrations or diagrams duplicated.

There is no radio book published today which is so modern, up-to-the-minute, and which contains so much useful information as is to be found in this single volume. It is a book that will outlast any other radio book in print. Look carefully at the photograph of the complete edition on the opposite page. It measures 9" wide, 12" long, 4½" thick.

Included in this volume is a complete radio servicing course. This course covers every step needed to learn the servicing business . . . from starting in business . . . materials needed . . . and how to go about servicing receivers and repairing other radio equipment. This course in itself, is actually worth the price of the entire book.

Our new plan now enables every radio man to get this single volume—a Complete Directory of all Circuit Diagrams, of over 2,300 pages, on deferred payments. You can order this book immediately—get it in a few days, and use it while you are doing servicing work. You can make the first few calls pay for the entire cost of the book.

For you to get this book is quite simple and it is sent to you as soon as your order is received. You pay for it in small monthly amounts which can be taken from your earnings. If you were to buy the three volumes separately, the total cost would be \$17.00, including the supplements.

Now you can get the

1931 OFFICIAL RADIO SERVICE MANUAL, with Supplements,
1932 OFFICIAL RADIO SERVICE MANUAL, with Supplements,
and the 1933 OFFICIAL RADIO SERVICE MANUAL Complete
at a big saving.

THE SPECIAL NEW PRICE FOR ALL THREE MANUALS, WITH SUPPLEMENTS, IN ONE VOLUME, WITH HEAVY BINDER IS ONLY

\$14.00

You buy this book this way—

Send \$3.00 with order—

Pay \$5.00 to Express Company upon receipt of book.

Send \$3.00 thirty days after receipt of book.

Send \$3.00 sixty days after receipt of book.

Total \$14.00.

IF THE ENTIRE AMOUNT IS SENT WITH YOUR ORDER, WE WILL ALLOW YOU A 10% DISCOUNT. THIS CAN BE DEDUCTED FROM YOUR REMITTANCE.

IMMEDIATE SHIPMENT

Mail Coupon Today!

GERNSBACK PUBLICATIONS, Inc.,
96-98 Park Place, New York, N. Y.

Gentlemen:

In accordance with your Special Offer, I enclose herewith \$3.00 as first payment toward the One Volume Radio Manual. Please forward it to me promptly. Upon receipt of the book, I shall pay express company \$5.00. Thirty days later I shall send you \$3.00, and sixty days after receipt of books, I shall send you my last payment of \$3.00.

If you want to take advantage of the Special Discount of 10%, remit only \$12.60 with this coupon.

Name

Address

City State RC-433

Over 2,300 Pages

Over 5,500 Illustrations

**THIS IS THE GREATEST SINGLE
VOLUME RADIO BOOK IN PRINT TODAY**

GERNSBACK PUBLICATIONS, Inc.

96-98 Park Place

New York, N. Y.

Servicing Book!

Over
2,300 pages
Over
5,500
Illustrations

Consolidated
Official Radio
Service Manuals

Consolidated Official Radio Service Manuals

Complete Radio Servicing Guide

Up-to-date Directory
of all
Commercial Radio Receivers

TRADE IN

Your Obsolete Tester
for a Modern \$90

"SUPREME" ANALYZER

at a total
cost of only **\$39.50**



A modern Model 401 remanufactured from a Pattern 199 Jewel.

Stop losing time, temper, MONEY with out-of-date testing equipment. Your old tester and only \$39.50 bring you the modern \$90 "SUPREME" Analyzer Model 401. "Supreme by Comparison" in every detail of construction and utility—many exclusive "SUPREME" features. Complete resistance analysis made directly on the Analyzer panel. Tests all the new tubes, including 4, 5, 6, and 7-prong types. Modern copper oxide rectifier meter for output measurements—unexcelled resistance ranges. And at a total cost to you of only \$39.50—with your old tester.

GET THE "SUPREME" PLAN
Write for Folder No. 401

Supreme Instruments Corp.
Greenwood, Dept. 458 Miss.

FORDSON

announces a new and better midjet radio
AT THE LOWEST PRICES EVER
QUOTED!

THE NEW SIX TUBE

Goldentone \$12.85 COMPLETE LESS TUBES

Superheterodyne
With automatic
volume control

Six R. C. A. licensed
tubes for \$4.65 extra

Mass production enables us to quote the
lowest prices. Buy direct from manufacturer.

WE REFUSE TO BE UNDERSOLD!
FREE CIRCULAR GIVING
COMPLETE INFORMATION
FORDSON RADIO MFG. CORP.
11700 Livernois Ave. Detroit, Mich.

POSTAL UNIVERSAL KIT SET

(Continued from page 589)

With an antenna only 20 ft. long and no ground connection, there has been no difficulty in picking up many distant stations, with receivers located at points around New York City. This has been made possible by so arranging the positions of the components and the constants of the circuits that operation of the manual volume control R7 permits the circuit to become regenerative and, if desired, to oscillate, near the maximum volume position of this unit. In order to maintain exact resonance in the tuned circuits throughout the broadcast band, and thus secure maximum sensitivity and selectivity over this range, the special R.F. coils, L1, L2, are accurately matched at the factory by means of an oscillator set-up. Adjustable vanes are provided on tuning condensers C1A and C1B for rough adjustment of the tuned circuits at several points in the broadcast band; trimmers shunt C1A and C1B. Thus the constructor is assured that these components may be accurately and conveniently aligned. The undistorted power output of this set is approximately 500 milliwatts.

Operation of the completed receiver may be checked, and possible faults in wiring immediately localized, by checking the operating potentials against the following figures; these were obtained by measuring the voltage between the respective tube elements and the negative side of the 110 V. power line:

Tube	Plate	S.-G.	Cath.	No. 1	No. 2
Type	Volts	Volts	Volts	Volts	Volts
39	100	100	1. to 35*	12	6
36	100*	13.5	3 (app'x)	0	6
38	100	100	13.5	12	18
25Z5	105	—	—	18	43

*Unless measured on a V.T. voltmeter the reading will be less.

Constructional and Circuit Features

Due to the fact that the rectifier tube, V4, "absorbs" 25 V. of the available power supply, it is possible to use a 50 W. "bleed" resistor, R6, of only 155 ohms. By spacing out this resistance-wire on a long, asbestos-covered metal strip, as shown in Fig. C, the heat is held to a low value and is thus most effectively dissipated.

Thomas W. Crossley, chief engineer of the company, has completed a novel arrangement of the detector circuit which results in maximum signal sensitivity with undistorted audio output. This circuit variation takes advantage of the fact that a screen-grid tube operating into a resistance of high value should be operated with a low screen-grid voltage in order to secure these advantages in operation; therefore, since the power tube re-

quires about 13.5 V., which also is the recommended screen-grid voltage for V2 (with the plate voltage available through load resistor R3) the screen-grid of V2 is directly connected to the cathode of V3, the voltage drop across the bias resistor R5 supplying to the screen-grid of V2 a potential which is positive with respect to it. Thus, resistor R5 serves a double purpose. Another point of interest is the use of C6 (from the insulated frame of the reproducer to ground); it eliminates a source of resonance hum.

The bypass condenser C3 in shunt to the primary of the output transformer T serves the dual function of compensating the high-frequency response characteristic of the output pentode circuit and at the same time serving to resonate the primary circuit to a lower frequency, thus doubly aiding to increase the effective low-frequency response.

Of particular importance to those who may wish to operate this set on storage batteries is the fact that the total current drain ("A," "B" and "C") is less than 3 A. On 110 V. the total power drain is only 35 W.

By reference to the following List of Parts, it will be noted that electrolytic condensers and other space-conserving units are specified. If desired, tubes and a special carrying case are available, as indicated in the supplementary data in the List of Parts. Inquiries concerning this extremely simple, effective and inexpensive kit-set, if directed to the attention of the writer, will receive his prompt, personal attention.

List of Kit-Parts

- One Postal high-gain antenna R.F. tuning coil, L1;
- One Postal high-gain interstage R.F. tuning coil, L2;
- One Kenyon choke coil, 30 hy., part No. KC-490, Ch.;
- One Postal two-gang, 350 mmf. tuning condenser, C1A, C1B;
- One Cosmic .01-mf. coupling condenser, C2;
- Two Cosmic .002-mf. tubular condensers, C3;
- One Micamold 500 mmf. condenser, C4;
- One Cosmic .006-mf. tubular condenser, C5;
- Two Cosmic .05-mf. tubular condensers, C6;
- One Micamold 8 mf. electrolytic condenser, 200 volts, C7;
- One Micamold dual 4mf. electrolytic condenser, 200 volts, C8;
- One Micamold dual 5 mf. electrolytic condenser, 35 volts, C9;
- One resistor, 300 ohms, 1 W., R1;
- One resistor, 35,000 ohms, 1 W., R2;
- One resistor, 0.2-meg., 1 W., R3;
- One resistor, 1 meg., 1 W., R4;
- One resistor, 1.500 ohms, 2 W., R5;

(Continued on page 625)

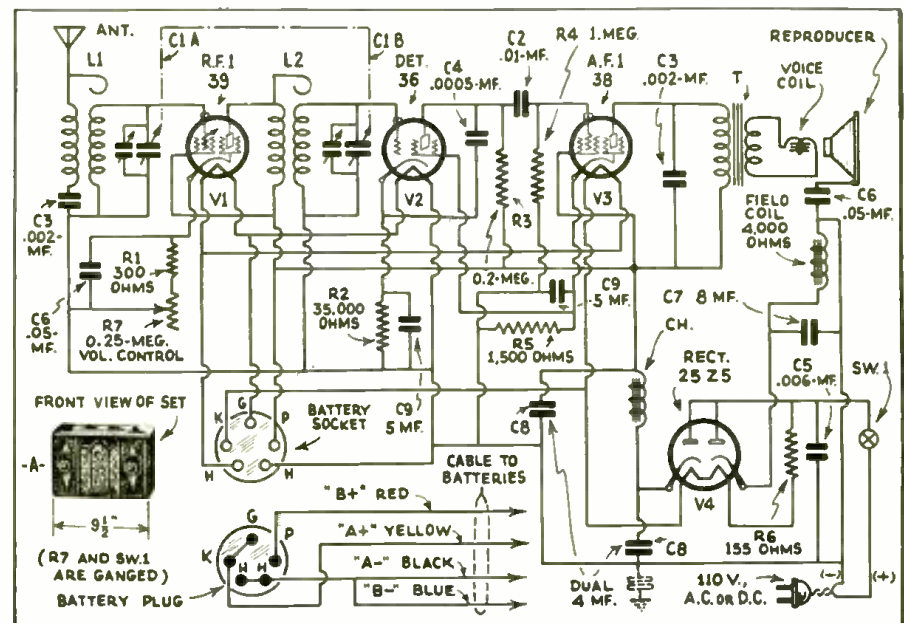

Fig. 1.

TUBE TESTER

(Continued from page 607)

and may be built at a cost of \$11.85. The counter model may be assembled for \$10.00. The special etched-lithographed panel measures 8 x 10 inches, and is drilled for mounting all sockets, switches, and the meter. Also, there are screw holes for supporting the panel. An itemized list of everything needed is given at the end of this article. The ten wafer type, floating contact sockets should be mounted on the panel as shown in Fig. 2. Be sure to mount the proper socket in its exact location and position on the panel, otherwise the tube type number on the panel would not correspond to the sockets, and the wiring would not conform to the directions.

Construction Details

Turn the panel over so that its under-side faces you. Refer to Figs. 2 and B. Fasten the three 4-prong sockets, V6, V7, V8, in the positions shown at the right by means of small screws and nuts. The filament contacts of each of these sockets should be at the base. Next, mount the three 5-prong sockets, V1, V2, and V5, as shown, one of them at the lower right-hand corner, and the other two on the upper left side. The filament holes should be in the position shown. The three 6-prong sockets are mounted so that two of them are in the center at the top of the panel, V9 and V10, and the other is second from the bottom on the left hand side, V3. Filament holes are in the position shown. The 7-prong socket, V4, is mounted in the lower left-hand corner with filament holes as indicated. If desired, the panel may be procured with all the sockets rigidly mounted with eyelets.

The meter is mounted next, and secured in place by means of the holding screws inserted in the movable ears on the back of the meter.

The jack switch, Sw. 1, should be mounted in the hole marked "short-regular." It is important to adjust the locknut and washers so that the switch will have positive action in its "in" and "out" positions. The jack levers should have a clear make and break in the two positions.

The S. P. D. T. toggle switch, Sw. 4, should be mounted in the hole marked "222-232-234." The position of the switch should be such that that end of the switch holding one terminal should point toward the line-voltage switch, Sw. 2.

Insert the 4-point selector switch, Sw. 2, in the hole marked "line voltage," and tighten by means of a locknut. Its position must be so aligned with the indicator knob that the dot on the knob and the contact terminals correspond to the markings on the panel.

A small fibre sub-panel is used to mount the two momentary contact push switches, Sw. 5 and Sw. 6. This sub-panel is supported by fastening it between the panel and the 7-point selector switch, Sw. 3, mounted in the hole marked "filaments." Around this hole is also a contact strip leading to the shell of the miniature lamp socket. Fasten the 7-point switch and knob so that its positions correspond to the markings on the panel.

Insert the switch buttons in the holes marked "second plate," Sw. 5, and "bias test," Sw. 6, before the filament selector switch is tightened. Be sure that these momentary contact switches are securely mounted so that pressing the button will give a sharp break of one circuit and a positive make of the other. Be careful that the two circuits are not closed at the same time in any position of the button. Mount the large 10 watt, 900-ohm resistor, R1, as shown in the diagram. The wiring procedure is as follows:

- (1) Wire all the filament terminals of the sockets, exactly as shown in diagram of Fig. 1.
- (2) Connect the cathode terminals to the filaments just as indicated.
- (3) Wire the socket plate terminals and follow the diagram.
- (4) Connect the control-grid terminals together as per diagram.
- (5) Wire the remaining grid connections as shown on the diagram.
- (6) Connect one end of the 7,000-ohm, wire-wound, pigtail plate-circuit resistor, R2, to the negative terminal of the meter. The other end of the resistor is connected to the plate terminal of the socket above the meter. Be careful not to bend the portion of the resistor leads colored brown or green, as you may break the thin wire connections and open circuit the resistor.
- (7) Connect the large 10-watt resistor, R1, according to the diagram.
- (8) Wire the multi-circuit jack switch,

(Continued on page 622)

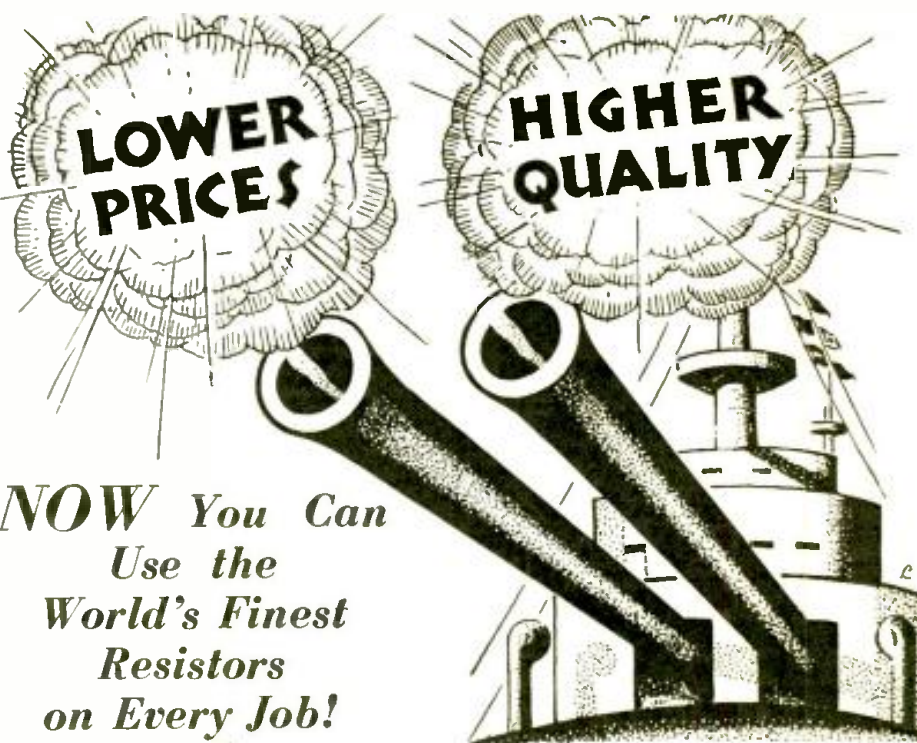

IRC PRICES REDUCED

SUBSTANTIAL reductions on list prices of the entire line of IRC Metallized Resistors and Kits as well as 5 and 10 watt Power Wire Wound Resistors and Motor Radio Suppressors become effective March 15th—a step which means breaking down the last barrier to enable service men to standardize exclusively on the world's finest and best known line.

IRC
Metallized
RESISTORS

1-Watt Metallized Resistors now cost you only 12c each instead of 18c. 2-Watt Resistors were 24c; now 18c. Other values also reduced.

No longer is there the slightest excuse for using Resistors of questionable performance "just because they are cheap." Now you can use IRC's all of the time—for all of your jobs.

But Price is only part of the story. High as IRC standards were in the past, new manufacturing processes and equipment have resulted in still further refinements which insure the utmost accuracy, exceptional performance under load, absolute uniformity and dependable operation under all atmospheric conditions.

IRC
POWER
WIRE WOUND
RESISTORS

Formerly 30c. 5-Watt Power Wire Wound Resistors are now only 21c. 10-Watt size 30c. Motor Radio Suppressors reduced from 30c to 21c each.

Price without Quality means nothing. Combined with Quality-plus, however, it forms an unbeatable combination—an outstanding opportunity for simplified stocks, greater service satisfaction and larger profits.

Order complete IRC assortments — today!

IRC offers numerous service helps and booklets, many of which are obtainable FREE with kits. Write for new price list and catalog of our full line.

INTERNATIONAL RESISTANCE CO.

74 Wellington St., W.,
TORONTO, ONT., CANADA

2006 Chestnut St.,
PHILADELPHIA, PENNA.

TALKING BEAM

(Continued from page 593)

dous bands of frequencies that are available by this new method, we wonder why more effort has not been put on systems to relieve the terrible congestion that now exists in the present broadcast channels. The frequency of the ionizing current gives us one channel to work on. Now, if we take another searchlight and change the ionizing frequency, say, 10 or 20 kc., we have another channel—and so on for the entire broadcast band. Mercury has three spectral lines, yellow, green, and blue. In the recent broadcast we used the blue line. This means that we can have 600 searchlights using the 600 channels on the blue line, with 600 more channels on the yellow line of 600 other searchlights, and still 600 channels on 600 more lights using the green line. At first this statement may seem wild, but anyone who will take the time to investigate the system will find that things have not been misrepresented.

This opens up a tremendous field for Service Men because one of the best ways to take care of an apartment house would be to have one large reflector on the top of the apartment and the audio developed in each cell could be "piped" down through the building at 500 ohms and rented to each subscriber so he could plug the program into the phonograph jack of his present broadcast receiver.

It is only necessary to stop and think for a moment to see the tremendous value of this system to armies and navies, both in time of peace and in time of war.

In summing up this brief outline, it would seem that inventions in the metal-vapor induction-lamp field have set a new mark for high quality communication systems. The directive qualities may be used if desired, or the complete 360 degree servicing of any area by well-known lens systems. The horizon being the boundary of interference between cities, together with an almost unlimited frequency response for television, augurs well for this system of communication which will be bound to show startling advances in the near future.

TRANSFORMERLESS RECEIVER

(Continued from page 620)

One Jensen electro-dynamic speaker for one 43 output tube and 4000-ohm field, type SpE14;
 One Radio Condenser Co. 2 gang .00035-mf. condenser, type CrE14, Cg1, Cg2;
 One Coast-To-Coast filter choke 15 hy., 30 ma., type ChE14, Ch;
 One Gen-Ral antenna coil, type L1E14, L1;
 One Gen-Ral R.F. interstage transformer, type L2E14, L2;
 One Gen-Ral R.F. untuned transformer, type L3E14, L3;
 Two El-Menco mica condensers, .006 mf., type 2438A, C1, C8;
 Three Solar paper tubular condensers, .1-mf., 200 volts, type 6706A, C2, C3, C7;
 One Solar electrolytic 8 and 4 mf. dual condenser, 175 volts, type C4E14, C4, C10;
 One El-Menco mica condenser, .00015 mf., type 2438B, C5;
 One El-Menco mica condenser, .0003-mf., type 2438C, C6;
 One Solar electrolytic, 5 mf., 35 volts, type C7E14, C9;
 One Solar electrolytic, 12 mf., 175 volts, type C11E14, C11;
 One Lynch resistor, 25,000 ohms, 1/3 watt, R1;
 Two Lynch resistors, 500,000 ohms, 1/3 watt, R2, R7;
 One Lynch resistor, 1,000,000 ohms, 1/3 watt, R3;
 One Lynch resistor, 600 ohms, 1/2 watt, R4;
 One Lynch resistor, 50,000 ohms, 1/3 watt, R5;
 One Lynch resistor, 20,000 ohms, 1/3 watt, R6;
 One El-Manco, 150-ohm, 15 watt wire wound resistor, R8;
 One Electrad 10,000-ohm potentiometer with special taper and 400 ohms minimum resistance, R9;
 Four Cinch miniature, 5 prong wafer sockets, S1, 2, 3, 4;
 One Cinch miniature, 6 prong wafer socket, S5;
 Five RCA tubes: two 44, one 85, one 43, one 25PZ5;
 One Line cord with plug;
 Miscellaneous hardware, wire, knobs, etc.



Oscillator, Tube-checker, Analyzer. For Analyzer method.

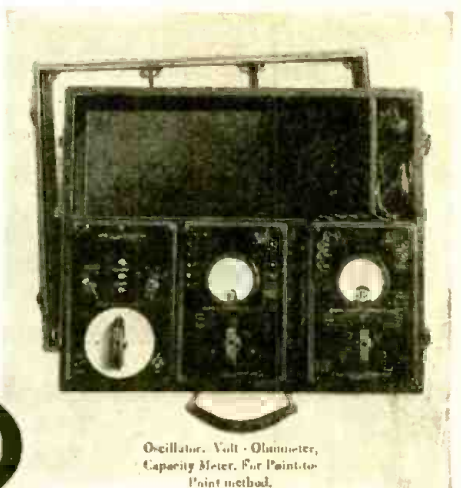

Oscillator, Volt-Ohmmeter, Capacity Meter. For Point-to-Point method.

2

Profit Producing Service Kits

See them at your jobbers

Convenience and accuracy have been combined in these two modern combinations of Weston Standardized Service Units. They are business builders. Either combination quickly and surely gets at the root of the trouble.

For the ANALYZER-TUBE-CHECKER method Weston offers the combination of Model 660 Analyzer, Model 661 Tube-checker and Model 662 Oscillator. For those preferring the POINT-TO-POINT method, Model 663 Volt-Ohmmeter, Model 664 Capacity Meter and Model 662 Oscillator provide the ideal combination.

Every service man should get all the facts about these two combinations of Standardized Service Units. Mail the coupon for complete information.

Weston Electrical Instrument Corporation, 599 Frelinghuysen Avenue, Newark, New Jersey.

WESTON-JEWELL

Radio Instruments



Model 677 Weston Tube Seller.

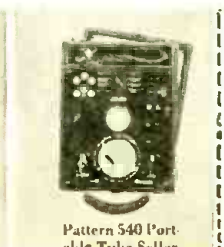

Pattern 540 Portable Tube Seller.

WESTON ELECTRICAL INSTRUMENT CORPORATION
 599 Frelinghuysen Ave., Newark, N. J.

Please send me further information
 on Weston-Jewell Service Equipment.

Name.....

Address.....



THERE'S MONEY IN THIS BOOK FOR YOU!

Servicemen and dealers are finding it mighty profitable . . . this new **CENTRALAB VOLUME CONTROL GUIDE**.

Replacement business is good business these days . . . are you getting your share? This 50c Guide will be sent to you upon receipt of two three cent stamps to cover mailing costs.

Send for it on your letter head . . . use it . . . discover how a mere handful of Centralab controls will service almost any old or new set.

Centralab
CENTRAL RADIO LABORATORIES
930 E. Keefe Ave. Milwaukee, Wis.

To Assure the **PEAK EFFICIENCY** of the **DOUBLET ANTENNA** and the **NOISE REDUCTION** of the **TRANPOSED TRANSMISSION LINE**

NATIONAL HAS CHOSEN LYNCH
SHORT WAVE ANTENNA PRODUCTS FOR THE NEW F-7
RESULT

The LYNCH Short Wave Antenna Kit

- KIT CONTAINS**
- 15—LYNCH Transposition Blocks—(These Blocks Are Non-Hygroscopic, Low Capacity and Low-loss Power Factor)
 - 8—LYNCH Commercial Type Insulators (Same High Quality Insulating Material As The Transposition Blocks)
 - 1—LYNCH Doublet Coupler (Transmission—Line Impedance-Matching Device)
 - 125 ft. Enamelled Short Wave Antenna Wire
 - 1—Thoroughly practical and well illustrated instruction booklet.

LIST PRICE, Complete \$5.00
At All Lynch and National Jobbers.

Though Designed Especially for the **F-7** The Lynch Short Wave Antenna Kit Will Improve The Performance of Any Receiver.

LYNCH MANUFACTURING CO., Inc.
711RP—General Motors Bldg., New York, N. Y.
Makers of the famous Lynch Resistors

The Original **"GEN-E-Motor"**

A fool proof dynamotor B battery eliminator for automotive and farm use. It is extremely economical, it does not require oiling, it has no tubes, relays, or vibrator points to cause trouble, will not overheat, dynamically balanced, mounted on rubber, and is equipped with a double filter system that completely eliminates noise.

Write for interesting circular giving complete descriptions and prices for Pioneer Equipment.

PIONEER GEN-E-MOTOR CORP.
2251-R Lawrence Ave., Chicago, Ill.

TUBE TESTER

(Continued from page 619)

Sw. 1, following the diagram. Note that only 5 terminals are used. Be sure to connect the correct wires to the right terminals. (9) Wire the toggle switch, Sw. 4, following the diagram. (10) Wire the "second plate" switch, Sw. 5, as shown. (11) Connect the "bias test" switch, Sw. 6, according to the diagram.

Final construction data are as follows:

(1) Insert the lead with the control-grid cap through the panel and connect as per diagram. (2) Insert the Belden rubber cable through the panel and connect one wire to the "common" side of the filament at the socket as shown. The "common side" is the filament terminal which is connected to or is common with the cathode. It is important that the same wire connecting the filaments is the common one for every socket. Connect the other wire of the Belden cable to the terminal feeding the switch arm of the line-voltage switch. (3) Connect the switch arm terminal of the filament switch, Sw. 3, to the filament terminal of one of the sockets according to the diagram. (4) Follow the diagram in wiring the transformer connections. The two black wires from the transformer are connected together and then to the "common" side of the socket filament terminal. The three primary leads, red and black, red and black (large stripes), and red, go to the 105-115-125 volt taps on the line switch, Sw. 2, in the order named. It will be necessary to splice short extensions (about 3-inch wires) onto the transformer primary leads for these connections. The joints should be well soldered and taped. (5) Connect the transformer secondary leads to the terminals of the filament switch as follows (from right to left with panel reversed):

TUBE	CHANGE	TUBE	CHANGE
00A	14	44	12
01A	6	45	9
10	6	46	12
12	10	47	13
20	4.5	49	11
22	2.5	50	7
24	15	51	16
26	11	52	12
27	12	55	14
30	5.5	56	19
31	7.5	57	21
32	10	58	17
33	9	59	13
34	5	71A	7.5
35	13	85	12
36	13	89	10
37	12	99	3.5
38	11	LA	13
39	12	80	25
40	6	81	25
41	12	82	25
42	12	83	25

A tube chart prepared by the author showing the changes in meter readings for various tubes. Only a few of the modern tubes are shown; others may easily be determined.

Green wire to terminal 1, red wire to terminal 2, yellow wire to terminal 3, brown wire to terminal 4, blue wire to terminal 5, white wire to terminal 6, black (red tracer) wire to terminal 7.

(6) Carefully check over all connections with the diagram and the instructions, as the

(Continued on following page)

MODERNIZE Your Analyser

General directions and diagrams for replacing the 906WL or 907WL Analyser Plug and Associate Adapters for the UY plug of any set analyzer, also for substituting the new Composite and Seven-Contact Sockets for the UX and UY analyzer panel sockets are furnished free with orders for same.

907WL Na-Ald 7-Prong latch-lock analyzer plug.
List Price.....\$3.50

907WLC Above plug with five feet of EIGHT wire cable. Eighth wire insures adaptability to possible future developments.
List Price.....\$5.50

This new plug has a seven prong base which is reduced to a 6, 5 or 4 prong base by locking on the following adapters:

976DS 7-hole to 6-prong adapter with locking stud.
List Price.....\$1.25

975DS 7-hole to 5-prong adapter with locking stud.
List Price.....\$1.25

974DS 7-hole to 4-prong adapter with locking stud.
List Price.....\$1.25

Replace the present UX socket of analyzer with the 456 or 456E composite socket which takes 4, 5 and 6 prong tubes and the present UY socket with the 437 or 437E seven hole socket.

456—50c, 456E—60c,
437—35c, 437E—40c

DETAILED ANALYZER REWIRING INSTRUCTIONS

When ordering your new 6- or 7-prong Latch Lock Analyzer Plug, Associate Adapters, Composite and Seven-Contact Sockets, include an extra \$1.00 net for detailed instructions, including parts list and revised diagram for modernizing your commercial set analyzer. These directions are by F. L. Sprayberry of Washington, D. C., and entitle the purchaser to individual consultation with him in case of any difficulty. These instructions may also be obtained separately at \$1.00 net each. Slate make and model of your set analyzer when ordering.



950X YL

SPECIAL 80 IN 1 ADAPTER

Here's what you have been looking for—nothing like it—highgrade tube checking adapter—tests over 70 tubes. No leads—no jacks or plugs—no complicated directions. Resistances and toggle switch for instant reading of both plates of dual plate tubes—beautifully and ruggedly made—a typical Na-Ald product. List \$6.00. Servicemen's postpaid price \$3.75. Orders filled in sequence received. Do not delay—send order today. Tubes it will check in practically any checker are 1, 2A3, 5Z3, 14, 15, 19, 29, 33, 36, 37, 38, 39, 11, 42, 43, 44, 46, 47, 48, 49, 52, 55, 57, 57A, 58, 58A, 59, 64, 65, 67, 68, 69, 70, 75, 77, 78, 80, 82, 83, 84, 85, 88, 89, 90, 92, 95, 98, 291, 293, 295, 95G, 98G, AD, AF, AG, C-2, C-4, G-2, G-4, GA, KR-1, KR-20, KR-22, KR-25, KR-28, LA, PA, PZ, PZII, Wunderlich A and Auto.

No. 950XYL. Servicemen's price \$3.75 postpaid. If your checker has no filament-voltage switch, use No. 951 SGL on base of 950XYL.

No. 954SGL. List price \$1.25

9PL—New Universal Out-put Meter Adapter. Contacts the plate prong of 4, 5, 6 or 7 prong tubes whether small or medium based. May also be used for connecting pick-ups, microphones, phones, tone controls, etc. Insulated for use in new shielded sockets and provided with five foot lead. List price, each 50c. Send 10c for 40 Page Adapter Data Booklet—over 300 diagrams of adapters for every purpose—description, use and directions are given. Tube terminals of the new tubes are shown, adapters for pickups, microphones, output meters, tone control, shortwave converters, etc.

Write for literature on adapters for testing 25 and 30 volt tubes in your present tube checker.

Servicemen's Discount 35%
On orders amounting to \$10.00 List 40%

ALDEN PRODUCTS CO.
Dept. R4 715 Center St.
BROCKTON, MASS.

tester is now completely wired. Mount the transformer by means of screws and bolts to the upper side of the case. Screw the pilot light in the miniature socket and insert the attachment plug in an A.C. socket for test. Follow the operating instructions carefully when testing.

If everything is satisfactory, screw the panel down to the supports, and the checker is ready for active service.

Operating Instructions

Connect the plug to a 60 cycle, A.C. line. Turn the "line voltage" switch to a position corresponding to the actual line voltage present. Switch Sw. 4 should always be thrown to the left except when testing a 222-232 or 234 tube, when it should be thrown to the right.

All tube numbers are marked on the panel alongside the sockets in which they are tested. After each tube number is a dash and a second number. The second number indicates the position of the filament switch, Sw. 3. For example: to test a 47 tube, look on the panel alongside 5-prong socket, which reads 47-3. Turn the filament switch to 3 and put the tube in the socket. Test for "Short" by pulling up switch Sw. 1, marked "short-regular." The pilot light glows for a shorted tube. Push down the "short-regular" switch for regular tests. "Regular" readings are now indicated on the meter. Press the "bias test" button, Sw. 6, and take the reading. The "difference" between "regular" and "bias test" readings is an indication of the transconductance, or mutual conductance, of the tube. Normal readings for good tubes are shown in the chart. Tubes are considered poor if the actual "difference" between readings is less than 25% from the "difference" listed in the chart.

Second plates of rectifiers are tested by pressing button Sw. 5, marked "2nd Plate."

If the line voltage does not correspond to the setting of the line voltage switch, the readings will be correspondingly slightly higher or lower.

List of Parts

- One Dependable panel, drilled and lithographed, 10x8 in.;
- One Dependable transformer, P.T.;
- One Dependable meter 0-15 ma., specially calibrated;
- One Dependable 7-point rotary filament selector switch, Sw. 3;
- One Dependable 4-point rotary line voltage switch, Sw. 2;
- One Dependable 6-leaf jack switch, Sw. 1;
- Two Dependable 3-leaf momentary contact switches, Sw. 5, Sw. 6;
- One fibre sub-panel for Sw. 5 and Sw. 6;
- One Dependable S. P. D. T. toggle switch, Sw. 4;
- One Belden soft rubber plug and cable;
- One miniature socket shell for "short lamp";
- Three 6-inch 4-prong wafer sockets, V6, V7, V8;
- Three Cinch 5-prong wafer sockets, V1, V2, V5;
- Three Cinch 6-prong wafer sockets, V3, V9, V10;
- One Cinch 7-prong wafer socket, V4;
- One 7,000-ohm, 3-watt resistor, 2% accuracy, piratical type, R2;
- One 900-ohm, 10-watt resistor, R1;
- Two knobs with arrow indicators;
- One pilot lamp, 18 watt;
- Two switch buttons for Sw. 5 and Sw. 6;
- One control-rod cap and connecting wire;
- One case, latherette covered portable carrying care (optional).

INFORMATION BUREAU

(Continued from page 615)

Address Power Amplifier.

(A.2) The schematic circuit of Fig. Q.190 shows how the circuit of the Webster Model B-112 Power Amplifier is arranged.

Only type 12A tubes are used to secure the maximum undistorted power output of 20 watts. The gain at 1000 cycles is 96 db.

A 6-volt storage "A" battery, a 300-volt "B" battery bank, and a 27 $\frac{1}{2}$ -volt "C" battery complete the power supply. This entire equipment, including a spring-wound phonograph turntable playing either 33 $\frac{1}{3}$ or 78 R.P.M. records and a phonograph pick-up, (also available are two 12-in. dynamic re-producers with 12-foot cords, and a 2-button microphone with 30 feet of cable and a 10-in. stand), is contained in a metal rack which measures only 18x18x31 ins. high. (The weight is 90 lbs.)

The control panel includes a pilot lamp, master volume control, and mixer control for use when it is desired to reproduce voice and music simultaneously.

1933 HAND BOOK Now Ready!



\$1
a year
including
3 supplements

BIGGER, SIMPLER, MORE COMPREHENSIVE than the 1932 edition which delighted more than 10,000 users. Lists full data on all resistors (including carbons) for all receivers. Saves service time and labor. Costs only \$1 a year, including 3 supplements. Send your dollar NOW! Satisfaction guaranteed or money returned after 10-days' trial.

Replacement VOLUME CONTROLS ALUMINUM Shafts—Snap-on SWITCH

Long ALUMINUM shafts, easily cut to desired length. Standard end cover may be instantly replaced by power-switch assembly, without disturbing control connections. Two ELECTRAD features, which service men are praising.

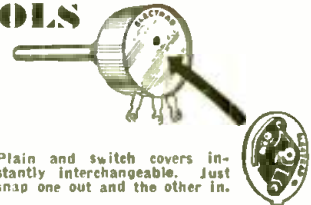

Plain and switch covers instantly interchangeable. Just snap one out and the other in.

Use TRUVOLTS for SAFETY



- 1—Patented construction permits air-cooling, larger wire, greater radiation and longer life.
- 2—Spiral winding provides better electrical contact.
- 3—Sliding clips assure accurate adjustment, 1,000 volt insulation.
- 4—Full-length fibre guard prevents injury from contact with tools or hands.

Write Dept. RC-4 for Complete New Catalog. 175 Varick St., New York, N.Y. **ELECTRAD**

COAST-TO-COAST RADIO ACCESSORY CATALOG AND PUBLIC ADDRESS AMPLIFIER SYSTEMS TREATISE WHOLESALE PRICES

Write for this Valuable 100 Page Book
CONTAINS THOUSANDS OF LISTINGS FROM A LUG OR SCREW TO A 100 WATT DUAL-CHANNEL-RACK AND PANEL PUBLIC ADDRESS AMPLIFIER

Available in Assembled Kit Form or FACTORY Wired
UNIVERSAL 110 VOLT AC-DC OPERATED TRANSFORMERLESS MINIATURE RECEIVER

Employs a DYNAMIC SPEAKER!
Uses latest Mercury Rectifier 25Z5 and a 43 Tube Providing 900 Milliwatts Undistorted Output—Amazingly Sensitive and Selective

FIVE TUBES REQUIRED: 2-44, 1-85, 1-43, 1-25 P2S.
Equipped with a SELF-CONTAINED AERIAL. Employing a 30 ft. long aerial, 1000-1600 mile reception is possible! Use of DYNAMIC SPEAKER assures remarkably faithful reproduction, and more than ample volume. Two tuning knobs and appropriate mechanisms are included—ones for tuning, and the other controls a switch and volume control in one. The use of THREE K.P. 6T7 tubes instead of TWO gives you the maximum SENSITIVITY and SELECTIVITY! A cadmium plated chassis is furnished WITH ALL PARTS MOUNTED THEREON. The simple wiring that remains to be done can be accomplished in any standard Over-all dimension: 10 in. long, 4 1/2 in. wide, 6 3/4 in. high. Covers 200 to 550 meters. Employs no power transformer, therefore break down is impossible! In using the latest design tubes, results are improved considerably in price.

Vacuum drawn 7 1/2 tube receivers! FULLY DESCRIPTIVE MECHANICAL AND ELECTRICAL BLUEPRINTS FURNISHED. (Separately obtainable for 75c.)

Factory Assembled Kit and Dynamic Speaker (Less Cabinet) **\$7.75**
and Tubes

Factory Wired—Ready for Immediate Use **\$9.95**
Set of Five Tubes **\$3.15**

Victor RE 32,45,57,75 Improved TWO STAGE PUSH-PULL "MIKE" PHONO-RADIO 4 to 7 1/2 WATT AMPLIFIER

Choice of Models Employing the following TUBES: 1-56 (OR 227), 2-245, 1-280 (OR 1-57 (OR 214A) 2-247, (OR 59) 1-280 (OR 83).

\$4.95

Equipped with a late design RCA Power Transformer, which makes possible the use of improved tubes of most recent design! High gain characteristics assure enormous volume on "mike" and phono-pickup. Furnishes 11 C. Field Circuit Excitation to a 2500 ohm 110 Volt Dynamic Speaker. Exceptionally ruggedly constructed, employs world's most renowned manufacturer's "MIRAL" COMPLETELY ASSEMBLED anybody can win the amplifier successfully. Fully descriptive blue-prints furnished. Fully Guaranteed—Your Complete Satisfaction is Assured!

4 WATT MODEL AMPLIFIER—(Less Tubes and Speaker) \$4.95
Amplifier, Genuine RCA Tubes and Wright De Coster Dynamic Speaker **\$12.45**

7 1/2 WATT MODEL AMPLIFIER—(Less Tubes and Speaker) \$5.95
Amplifier, Genuine RCA Tubes, and Wright DeCoster Dynamic Speaker **\$13.95**

CABINET ALONE \$1.95

PHILCO PERMANENT MAGNET DYNAMIC SPEAKER CHASSIS

Requires no Field Current Excitation—Duplex Performance of Electro-Dynamic Speakers!

The elimination of a field coil current supply necessarily permits the attachment of this permanent magnet dynamic speaker to any receiver or amplifier not furnishing such field coil supply! These speakers can well dissipate up to seven watts audio output without distorting or biasing! Can be employed as an "additional" or "extension" speaker and due to its self-contained output transformer, of unique design, the addition of this speaker to any other will not alter the efficiency of the speaker now being used. Ideal for multi-speaker! A system installation! Overall diameter, 8 1/2 in. Total depth, 4 3/4 in. The PERMANENT MAGNET itself is fully 1 1/2 in. long. Baffle hole required—7 1/2 in. diameter.

Philco Speaker, installed in an attractive Walnut Mantle Cab. **\$7.95** Chassis **\$5.95** only

COAST-TO-COAST RADIO CORPORATION
123 R. WEST 17TH STREET NEW YORK, N.Y.

RADIO-CRAFT for APRIL, 1933

623

www.americanradiohistory.com

They Look, Listen and Buy It!



There's no miracle about De Wald Dynette's big sale. It's just the most for the money. A fine engineering job—a five tube set—a dynamic speaker—a real burl walnut cabinet—a compact midget with a big, clear voice. And a great price.

\$25.00

Ask for Details
of De Wald's Dealer Deal

DE WALD DYNETTE

Pierce Airo, Inc.
516 Sixth Ave. New York, N. Y.

Make MORE MONEY in RADIO with R.T.A. Professional TRAINING

Home study with R.T.A.—plus lifetime membership in our large, powerful association of radio service men—brings you up to date on all improvements in radio, television, sound engineering, and keeps you among the real money-makers in this expanding field. Unless you have this high-type professional training you will find it hard to set out of the poorly paid "tinkerer" class.



New-Type Set Analyzer Included

As part of R.T.A. training you get this up-to-the-minute Set Analyzer and Trouble Shooter. After a few easy lessons you are ready to use it for immediate money-making, competing with "old-timers" without fear. With this wonderful piece of equipment, backed by R.T.A. professional training, you need have no fear or worry over the future. Even though there should never be a new radio set constructed—or not another improvement in radio made—there are enough sets now in service that need frequent attention to assure you good money as an accepted Radio-technician.

Start Money-Making Quickly

R.T.A. Training is especially designed—and given you by one of the outstanding teachers of radio technology in the world—to set you into the profitable end of radio quickly. It is not empty theory, but practical, down-to-earth work that makes you a money-maker in this immense field in the shortest possible time. Don't delay your start toward success! Write at once for all details about R.T.A. training. The Coupon below brings FACTS—astonishing ones that may open up a new, depression-proof future for you.

MAIL COUPON NOW!

RADIO TRAINING ASS'N. OF AMERICA,
4513 Ravenswood Av., Dep't. RCA-4, Chicago, Ill.
Send me all the FACTS about R.T.A. professional training together with information about the opportunities existing for R.T.A. Radiotechnicians today.

NAME
ADDRESS

OPERATING NOTES

(Continued from page 611)

the wires leading to it and then remove the two nuts holding the box in place. The volume control shown in the schematic remains right on the chassis front panel and is not removed with this box.

The left-hand box is removed in a similar manner, except that the A.C. switch must first be removed from the front panel: Pull the A.C. plug out of the wall socket, and then turn on the A.C. switch by pulling it out. With a pair of long-nose pliers, hold the shaft that now protrudes and turn the knob to the left. A specially shaped bolt is screwed onto the shaft. Now remove the round nut from the front, and the A.C. switch will fall back through the panel.

The chassis is fastened from the bottom by means of slot headed machine screws. Remove all of these screws. If the boxes have not been removed, disconnect them from the chassis. Remove the strip in the back holding the A.C. filament leads; two screws hold it in place. Lay it on the chassis without disconnecting the leads. It appears at first that the chassis could be removed by simply disconnecting the leads from the tubes. However, there is not enough room to lift up the chassis with this strip in the way. The front sheet-metal panel is held in place in two grooves by a wooden strip right above it. Remove the two screws holding this strip in place and then remove the strip. You are now ready to life out the chassis.

When replacing the two boxes, the cap-like washers on the bolts may be held in place by a rubber band or string as shown in Fig. 4B. This is a good thing to know, as many of the later Sparton sets used the washers also, and this knowledge will save a lot of time when getting them back in place.

Alignment and Neutralizing

The trimmer condensers are located right on the tuning condensers and can only be reached by removing the chassis. However, as most owners are probably now satisfied with local reception, you will not have many calls that will require readjustment of these trimmers.

Right near the antenna binding posts is the screw for the aerial compensating condenser. It is only effective, as can be seen from the schematic, when the aerial is on the "long" position.

You will probably find a number of jobs which require re-neutralizing. In the base, behind each of the three R. F. tubes is a hole through which a slotted head screw may be reached. A cold tube in any of the sockets is quickly obtained by merely disconnecting one of the overhead leads to the tube in the stage you desire to work on. Neutralization is then carried on in the regular manner. However, these sets will be found quite critical, and if adjusted at the high frequency end, may whistle and oscillate around 600 kc. Therefore, go over the neutralizing procedure at two or three different points on the dial. It is difficult and inadvisable to attempt to neutralize the set to a point where it does not whistle when full volume is turned on at the higher frequencies; this condition is normal, due to the lack of shielding. Also, it may be found that slight readjustments may have to be made with the tubes hot, as the dead spot as found with a cold tube is not always the best point for adjustment over the entire band.

"OPERATING NOTES"

In sending in "Operating Notes" for publication, please check up on information previously printed in this magazine so that you may avoid duplication. Such a procedure not only saves your editors a lot of work, but you save yourself the embarrassment of having your manuscript returned "unsuitable for publication."

DEPENDABLE TUBE TESTER KNOCK-DOWN KITS

COUNTER MODEL\$10.00
PORTABLE MODEL\$11.45
MODEL No. 301 PORTABLE
COMPLETE WIRED AND AS-
SEMBLED\$14.50

RADIO CITY PRODUCTS CO.
48 West Broadway New York, N. Y.

NOW READY

The RADIO-CRAFT INDEX

It contains a thorough, alphabetical and topical arrangement of EVERY article and subject which has been published in all the issues of RADIO-CRAFT from July, 1929 to June, 1932

Radio Men have conclusively proved to us the need and practicability for a book which has included in it, a comprehensive and complete listing of every article which has thus far been published in RADIO-CRAFT. A book which has each topic so sub-divided and cross-indexed that a mere glance at a subject will give you any number of classifications and uses of it. For example, if you look at tubes, you find under this topic, various sub-titles, general, power, transmitting, photo-cells, testing of tubes, thyratons, etc. Every article or notice in the book has been considered so deeply important that when you refer to a certain classification, listed below the main topic, you will find perhaps a dozen or more articles treating the subject from different angles. The author in each case is given—the exact issue in which the article appeared, and on what page it is to be found. So accurately compiled, by C. W. Palmer, one of radio's foremost writers, that in less than two minutes you can turn to any article—needless to wade through all the issues of RADIO-CRAFT which have been published during the past three years.

The RADIO-CRAFT INDEX is exactly the same size as the monthly magazine—it has 24 pages. It can be conveniently kept on file with the copies of the magazine—ready for quick reference. The index is printed on good paper with self covers.

This book is sold only by the publishers at 25c the copy. Mail coupon below for your copy of the RADIO-CRAFT INDEX.

Briefly outlined below appears only a partial contents of the book

AMPLIFIERS—	PATENTS—
ANTENNA SYSTEMS—	PHONOGRAPH REPRO-
CABINETS—	DUCTION AND RE-
CIRCUITS—	CORDING—
CODE	POWER SUPPLY AND
COILS AND TUNING—	BATTERIES—
COMPONENTS—	RECEPTION—
COOPERATIVE LABORA-	REMOTE CONTROL—
TORY—	SELLING AND MONEY
DETECTORS AND	MAKING SERVICING—
RECTIFIERS—	SET CONSTRUCTION—
EDUCATION—	SPEAKERS AND REPRO-
INTERFERENCE AND	DUCERS—
HUM ELIMINATION—	TELEVISION—
KINKS—	TELEVISION STA-
MANUFACTURING—	TONE AND VOLUME
METERS AND TESTING	CONTROL—
EQUIPMENT—	TOOLS—
MISCELLANEOUS—	TRANSFORMERS—
MOTION PICTURE	TRANSMISSION—
RECORDING AND	TRANSMITTERS—
PROJECTION—	TUBES—
MUSICAL INSTRU-	LIST OF BROADCAST-
MENTS—	SHORTWAVE AND
NEUTRALIZING—	TELEVISION STA-
NOVELTIES—	TIONS—

ABSOLUTELY NOTHING WHICH HAS APPEARED IN RADIO-CRAFT HAS BEEN OMITTED FROM THIS VALUABLE COMPILATION

Clip and Mail Coupon Today!

Publishers of RADIO-CRAFT, RC-433
96-98 Park Place, New York, N. Y.

Enclosed you will find my remittance of 25c (check, stamps or money order accepted) for which you are to send me, postage prepaid, one copy of the RADIO-CRAFT INDEX.

Name

Address

City

State

THIS BOOK CANNOT BE BOUGHT ON THE NEWS-
STAND—ONLY DIRECT
FROM THE PUBLISHERS THE COPY

25c

Build a TREASURE FINDER!



We supply
all Parts for Building
Electrical and Radio
**TREASURE
LOCATORS**

Radio, Audio, Ground Potential Measurements, Hughes Induction Balances and other types; including Oscillators and amplifying systems.

We supply all materials needed for building and operating any of the recognized treasure finders.

The following standard circuits are described in our bulletin:

- No. 1. Ground Potential, Leap-Frog Method.
- No. 2. Hughes Induction Balance Type A.
- No. 3. Hughes Induction Balance Type B.
- No. 4. Sensitive Hughes Induction Balance.
- No. 5. Simple Super-Sensitive Hughes Balance Circuit.
- No. 6. Radio Frequency Oscillator Circuit.
- No. 7. Audio Oscillator Circuit.
- No. 8. Single Search Coil Hughes Induction Balance with Audio Amplifiers.
- No. 9. Combination Radio Transmitter and Receiver circuit.

Also accessories such as High Frequency Buzzers, Audio Oscillators, Differential Current Transformers, Two Stage Audio Amplifiers, etc.

With any one of these systems you can locate buried treasures, metal war relics, mineral deposits, subterranean water veins, buried gas and water pipes, and lost objects, tools and treasures sunken in water, etc.

Write for pamphlet giving history and theory on this interesting subject. All above circuits and systems are described and explained. List of parts and prices included. (Price of Pamphlet 10c.)

Mail Coupon TODAY!

GRENPAK COMPANY Dept. RC
245 Greenwich St., New York, N. Y.

Enclosed find 10c for which kindly send me pamphlet on Treasure Finders.

Name

Address

City

State

TRAUTONIUM

(Continued from page 591)

former 33 having a ratio of 2:1 may also be used in conjunction with condenser 34 having a capacity of .01-mf. so as to form an additional circuit for accentuating the harmonics. This latter circuit may also be connected to the last tube, as shown in the schematic circuit. This arrangement is especially valuable when it is desired to simulate, for instance, the tones produced by a violin which has two distinct sets of harmonics, or overtones: one of them is produced by the air chamber inside the body of the violin, and the other produced by the vibrations of the body itself. With the two harmonic producers described, the two sets of harmonics may easily be obtained.

By means of potentiometer 28, the volume may be controlled. This unit is foot operated as shown in one of the photographs and is a carbon unit.

Editor's Note

The schematic circuits given and described by Dr. Noack are based on the use of German tubes. The experimenter, however, may try any of the triodes or screen-grid tubes now available, and use the values of parts specified in the article. The story as described here contains many suggestions for experimenters, and it leaves sufficient room to allow the experimenter to "change his mind." In forthcoming issues of RADIO-CRAFT, we will present additional interesting variations of the Trautonium described in detail in our March, 1933 issue.

Suggestions from those trying the circuit, or a short note from those interested in the design will be welcome. For a comprehensive treatment of thyratrons suitable for the purpose described in this article, the reader is referred to page 150 of the September, 1930, issue of RADIO-CRAFT in an article entitled, "The Thyatron—An Addition to the Vacuum Tube Family."

UNIVERSAL KIT SET

(Continued from page 618)

- One ballast resistor, wire wound, 155 ohms, 50 W., R6;
 - One Centralab resistor, 0.25-mcg., R7;
 - One on-off switch (mounted on volume control), SW.1;
 - One Rola dynamic reproducer (special), 4,000 ohm field, Field Coil;
 - Four five-prong sockets, V1, 2, 3, S;
 - One six-prong socket, V4;
 - Three screen-grid clips;
 - One Postal drilled and stamped chassis, 6 1/2 in. high, 9 1/2 in. wide, 4 1/2 in. wide;
 - One Postal cabinet;
 - One line-cord and plug;
- (Optional Components)
- One Postal carrying case;
 - One variable-mu R.F. pentode, type 38, V1;
 - One screen-grid tube, type 36, V2;
 - One power pentode, type 38, V3;
 - One dual half-wave rectifier type 25Z5, V4;
 - One 32 V. Delco power line adapter;
 - One 220 V. power line adapter;
 - One automotive-installation kit, (remote control leads, interference suppressors, hand-rail clamps, and antenna wire);
 - One Postal 135 V. automotive "B" eliminator.

ELECTRONIC MUSIC

For the past two months we have been publishing information on the construction and operation of electrical musical instruments. We will continue with this policy for we feel that electronic music will be one of the major "side lines" of the radio industry—it may even become an industry in itself.

Why not send in your ideas as to whether or not you agree with us in this policy.

*Still Greater
Opportunities
with*

OHIOHM

SPARK SUPPRESSOR SETS, for eliminating ignition interference on automobile radios, are furnished for 4, 6, and 8 cylinder cars. Each set contains condenser designed to withstand unusual conditions of temperature and vibration . . . also, necessary spark suppressors enclosed within porcelain tube to eliminate accumulation of dirt. Made of special non-moisture absorbing material to prevent shorting.

The life of an OHIOHM Suppressor is the life of the car.



*Check Resistors
for these
Cardinal Points*

- Accuracy—resistance value within 10% tolerance.
- Permanency—value unchanged by age.
- Absence of noise.
- Low Heat Coefficient.
- Freedom from Capacity Effect.
- Unaffected by Humidity.
- Low Voltage Coefficient.
- Mechanical Strength—ability to withstand rough handling.
- Appearance—straight wire leads, good paint finish, etc.
- Color Coded, Printed Values, Trade-Marked.

Cleanaire
ICE-BOX
and REFRIGERATOR
DEODORIZER

- Absorbs and destroys food odors . . . Prevents blending of flavors and tainted foods . . . Add this to your line . . . Exceptional profit . . . Write for facts.

THE OHIO CARBON COMPANY
12502 BERA ROAD, CLEVELAND, OHIO
OHIOHMS are made in Canada by
C. C. Meredith & Co., Ltd., 635 Bay St., Toronto



CONDENSERS

are now stocked by all
**LEADING
JOBBERs**

Ask your radio parts distributor to
show you this

COMPLETE LINE

and to give you an Official Entry Blank
for the

TOBE CONDENSER CONTEST

New low prices on Tobe Condensers
and Filterettes are given in the complete
Tobe Catalog 433-C, now ready.
Ask your jobber for a copy, or write

Tobe Deutschmann Corp.
Canton, Mass.

We guarantee that all TOBE products are
manufactured in our factory at Canton,
Massachusetts.

Voltage and Resistance Measurements

95% of radio-aet troubles can be located
quickly and accurately with the



SHALLCROSS No. 681 Quick-Change Volt-Ohmmeter

10 - 100 - 500 - 1000 volts
1 ohm to 3 megohms

This instrument is
very easy to build.
The important parts

required are a 1-milliampere D.C. meter
and the SHALLCROSS Resistor Kit No.
681.

Send 6c in stamps for Bulletin 681-P, describing
the service man's most useful test instrument.



Lowest Wholesale Prices!!! Servicemen! Dealers! "Hams!"

Write for latest bulletin sheets. We stock parts
of the following manufacturers: Aerovox,
Cardwell, Hammarlund, Dubilier, RCA, Hytron
tubes, Cunningham tubes, Flechtheim, Concourse,
Cornell, Baldwin phones, Electrad, Centralab,
Ohmite, Ward-Leonard, Signal keys, IRC re-
sistors, National, REL, DeForest, Cornish wires,
Pilot, Thordarson, Jefferson, Weston, Jewell,
Readrite, Yaxley, Elkon, Franklin transformers,
Standard replacement transformers, etc.

Our prices are always lower. Write for quotations.

You pay postage.

**ANY SIZE ORDER ACCEPTED.
SHIPPED DAY RECEIVED.**

MAURICE SCHWARTZ & SON
710-12 Broadway Schenectady, N.Y.

TEST PANEL

(Continued from page 599)

sequently, the resistance of the meter circuit
will be 100,000 ohms.

To measure low ranges of resistance, leave
S5 on the D.C. setting, turn switch S6 to A.,
and select the low-range scale on switch S18.

Position No. 4 of switch S-16 is the "off"
position and is the normal position for this
switch except when testing tubes, or when
using the meter with an external battery as
an ohmmeter or continuity meter.

External current or voltage measurements
are made with this analyzer by connecting the
test leads to the correct tip-jacks and manipu-
lating the switches required for the various
tests which it is possible to make.

To use the meter of the analyzer as an out-
put meter, connect the test leads to the "A.C."
tip-jacks and set switch S5 to the A.C. posi-
tion. The range of the meter can then be
controlled by means of switch S15. In most
receivers, the test leads will be connected to
the voice coil of the dynamic speaker in which
case the five or ten volt range of the meter
will be sufficient.

The Tube Tester

Fourteen sockets are required for this tube
tester, wired as indicated in Fig. 1B. Switches
are provided where necessary for switching
from one tube element to another.

Switch S7 of the tube tester is a single-
deck 8-point tap-switch. Eight contact and
one "off" position are available, as follows:

Tap No.	Volt- age	Tap No.	Volt- age	Tap No.	Volt- age
1	1.1 V.	2	2 V.	3	2.5 V.
4	3.3 V.	5	5 V.	6	6.3 V.
7	7.5 V.	8	14 V.	9	25 V.

The step-down transformer is especially
made for this tube tester, giving variable
voltages from 1.1 to 25 V. (A filament volt-
age of 25 V. is required, when testing the 43
and other special type tubes.) Switches S1
to S5, and S8, S9, are push-button switches;
S1 to S5 connect the various tube elements
to the common plate and the grid circuits,
and S8, S9 provide an oscillation test for
tubes with and without grid-bias change.
S6 is a three-point tap-switch. The primary
L2 and secondary L1 of the R.F. transform-
er used for oscillation tests are closely
coupled, on a single form.

Switch S10 is a toggle switch used to short
out the 400 and 2,250 ohm resistors when
testing rectifier tubes. Switch S11 is an off-
on unit which controls the operation of the
tube tester.

The table below lists the different type
tubes that may be tested in this tester:
Socket

No.	Tube Type
1-00A, 01A, 10, 11, 12, 12A, 20, 26, 30, 31, 40, 45, 50, 71A, 99, 182, 182A, 182B, 183, 586, 841.	
2-22, 32, 34.	
3-80, 81, 82, 83.	
4-BA, BH, BR.	
5-17, 27, 37, 56, 484, 484A, 485, 686.	
6-33, 46, 47, 52, GA, PZ.	
7-14, 24, 35, 36, 38, 39, 44, 51, 64, 65, 68, LA.	
8-91, 93, 95, G-2.	
9-Wunderlich—five-prong.	
10-29, 69, Wunderlich "A."	
11-55, 85.	
12-41, 42, 43, 49, PA, PZH.	
13-57, 58.	
14-59.	

The recommended procedure to test tubes is
as follows: Set S7 to secure the rated fila-
ment voltage of the tube being tested, insert
the tube in the correct socket and then turn
on S11. Allow the heater type tubes suffi-
cient time to reach the correct temperature.
After about 60 seconds, the plate-current
reading should become steady. Finally, de-
press switch S8 and take a second plate-cur-
rent reading. A large difference reading in-
dicates a good tube.

The normal position for switch S9 is for
the tube in an oscillating condition. How-
ever, when it is desired to stop the tube
circuit from oscillating, it is only necessary
to depress the "stop-oscillator" push-button.

Exact figures for relative tube efficiencies

(Continued on following page)

Announcing

the **SECOND**



THE BIGGEST NEWS-MAGAZINE IN
THE RADIO INDUSTRY

Issued Monthly for Radio
Service Men

This new magazine is filled with inter-
esting service information; plans of
the Association; Service Men's experi-
ences; answers to inquiries about
servicing; hints on making extra
money in the servicing field, in short,
it is a magazine written for and by
members of the O. R. S. M. A. It is
the voice of the Association in which
the problems and suggestions of the
individual members are presented for
review and discussion among the fra-
ternity. It is a magazine for, of and
by the Service Man, edited by the staff
of RADIO-CRAFT Magazine, sponsors
of the OFFICIAL RADIO SERVICE
MEN'S ASSOCIATION.

In appearance this BULLETIN is
made up in the style and size of a
tabloid newspaper. It contains up-to-
the-minute service information. A
partial contents of the second issue is
found below:

- Editorial:—The Independent Service Man's
Place in the Radio Industry.
- Announcement of the Associate Membership—
how to become an Associate, and the ad-
vantages to be gained.
- Servicing Experiences—Unusual service cases
and the way in which they were handled.
- Descriptions of service equipment—employed by
members.
- Down with the Service Gyps—a continuation of
the War on free service "Gyps."
- The Service Man's Own Forum—letters on all
subjects pertaining to the Association.
- Electrifying and Modernizing old receivers as a
source of income to the Service Man.
- Making Money at Servicing—methods of adver-
tising and extending business used by success-
ful Service Organizations.
- The Radio Service Man's Buying Guide—with an
index of companies which allow special dis-
counts to members.
- The Question Box—Questions asked by Service
men and the answers.
- Employment Service—Ads inserted by companies
looking for Service Men and members looking
for employment.

Subscription Rates for the O. R. S. M. A. BULLETIN

O. R. S. M. A. Members	Non-Mem- bers
50c	one year \$1.00
\$1.00	two years \$1.75
\$1.50	three years \$2.50
\$2.00	four years \$3.00
\$2.50	five years \$3.75

Price of Single Copy 10c

Subscription Blank

Executive Secretary O. R. S. M. A.,
98 Park Place, New York, N. Y.

Enclosed find my remittance of \$..... for which
please enter my subscription to your BULLETIN for
..... years.

- I am a member of The Association and my Member-
ship Certificate number is.....
- I am not a member, but would like to receive your
application blank to join the O. R. S. M. A. (no
fees—no dues to be paid by me).

Name

Address

City..... State.....

cannot be given, but by testing new tubes, known to be in good condition and tabulating these values you can always check the condition of a doubtful tube.

Two binding posts or tip-jacks are provided, MA, in the "B+" circuit to permit the milliammeter of the tube tester to be connected into the circuit for determining the condition of various tubes under test.

Pre-Heater

A pre-heater is provided just under the tube tester for pre-heating tubes where a large number are to be tested; the schematic circuit is Fig. 1E. Sockets are provided for all tubes in general use. A pilot light V indicates whether the pre-heater is in operation.

Where a large number of tubes are to be tested, a pre-heater is very desirable as it speeds up the testing of tubes so that many more may be tested in a given amount of time. You will find this to be a valuable adjunct to the test panel.

Tube Short Checker

The tube short checker, shown in Fig. 1F, is located just under the pre-heater and tests every element of one tube against all the elements of the same tube for possible short-circuits. The switch used is a Weston "bi-polar" type, (although the writer, in constructing his switch for this part of the panel, made one by using switch points mounted on two pieces of bakelite); one common shaft controls both sets of contacts. The switches are similar in construction to the Yaxley two-deck switches described for other parts of this tester. Such switches are rather difficult to make and therefore, it is recommended that a manufactured switch be obtained.

To test any tube for short-circuits, connect the ohmmeter of the set analyzer to the two binding posts or tip-jacks which connect to the two fixed contacts of the bi-polar switch. The switch is then turned from left to right, going from position 1 to position 15. If any of the elements of the tube under test are shorted, a reading will be obtained on the panel meter.

Variable Condenser Bank

Filter condensers rated at 1,000 V. were used in the construction of this bank which is shown at 1G. A capacity range of .05- to 8 mf. is provided.

Such a bank is particularly useful to check the condition of filter or fixed condensers or where it is desirable to use a larger capacity in a certain circuit. Test leads are connected to the binding posts or tip-jacks leading from the condenser bank. To use the bank, connect the test leads to the receiver circuit in which it is desired to use the extra capacity.

In many cases where there is a high hum level, it can be eliminated or reduced considerably by using a slightly higher capacity in some part of the circuit. You can tell quickly just how much capacity you require in order to reduce the hum level by using a bank of this type. Service Men usually find it necessary to connect several condensers in the circuit to make the test, but by using this method, several values can be tried and the correct one determined at once.

Field Coil And Load Resistor

Service Men have long been bothered with the problem of how to correctly service an A.C.-operated receiver without bringing the speaker which is usually used with the receiver, to the shop.

By using a heavy-duty 30 ohm choke and 250-watt 200 to 100,000 ohm variable resistor, as shown in Fig. 1D, you can substitute for practically any speaker field. In some cases, connecting the choke in place of the speaker field will be sufficient while, in other cases, it will be necessary to include more resistance in the circuit, in which case the variable resistor is used in connection with the choke.

Another important use for the load resistor is that you may be working on a power unit or power amplifier on which there is no load. Under such conditions, rather high voltage is applied to the filter condensers and it is possible that these may be punctured. The variable resistor may be con-

(Continued on following page)



WHOLESALE'S NEW MIGHTY BARGAINS

152 Pages packed with Mighty Radio Bargains. More than TEN THOUSAND listings of Super Values which will warm your heart. . . . Words can't begin to describe the amazing array of sensational offerings in this great new catalog. You have to see it to appreciate it.

SERVICE MEN'S HEADQUARTERS

Buy Direct from the Largest Organization of its kind in the world! Buy where you get "HIGHEST QUALITY at LOWEST PRICES"! WHOLESALE has given 12 years of Super Service to its customers. That's why so many Service Men buy from Wholesale's Catalog—"The Directory of Radio's Greatest Values"!

DUAL A.C. PORTABLE PUBLIC ADDRESS

WHOLESALE'S New Catalog features a Dual A.C. Portable Public Address and Amplifier at a price so low it will startle you. This is only one of ten thousand super values. Get the Catalog and get the facts!

Wholesale Radio Service Co., Inc.
100 Sixth Ave., New York, N. Y.

1933 CATALOG EVERYTHING IN RADIO

You can buy anything you want in Radio from the world's largest company of its kind through this BIG BARGAIN BOOK. Here is assembled an amazing array SETS, TUBES, SPEAKERS, REPLACEMENT PARTS, KITS, SHORTWAVE RECEIVERS and APPARATUS, AMPLIFIERS, etc. Then there are featured sections on LAFAYETTE RECEIVERS, TRUATEST PARTS, PUBLIC ADDRESS, etc. ANYTHING AND EVERYTHING in Radio at the LOWEST WHOLESALE PRICES IN OUR HISTORY!

Don't delay. Mail the coupon below for your copy of this 1933 Catalog—hot off the press!!!

Wholesale Radio Service Co., Inc.
100 Sixth Avenue, Dept. C-43, New York, N. Y.
Rush your 54th Edition 1933 Catalog.

Name _____
Address _____
Town _____ State _____

31 AC-DC BATTERY

31 UNIVERSAL KIT

For wide-awake Dealers and Servicemen—here is the very latest money making item offered for the first time in assembled kit form for \$9.75 which you can wire in less than one hour.

If you prefer, receiver may be purchased custom-built, wired, and tested for 95c additional. You can easily resell these sets to an unlimited number of prospects at a handsome profit.

This personal compact and convenient light-weight receiver may be operated from any power source (AC—all voltages and frequencies; DC—Deleo or Battery systems). No Restrictions. Works Everywhere—Automobiles—Motor Boats—Offices—Camps—Hospitals—Bedrooms—Dens—Hotels. Employs an R. F. Pentode, Screen-Grid Power Detector, A.F. Pentode and one Voltage Doubling Rectifier, incorporated into an advanced design circuit utilizing the latest Rola Dynamic Speaker. Tremendous volume and unusual sensitivity are easily attained on a few feet of wire. No ground or outdoor aerial necessary.

Complete Kit as described in this issue	\$ 9.75
One Special Cabinet	1.50
Matched set of R.C.A. or Eveready tubes	3.75
Leatherette carrying case	.75
Regular Price	\$15.25
SPECIAL OFFER: Complete as listed above	\$11.95
Complete receiver custom-built, wired and tested with cabinet, carrying case, and tubes, ready to operate	\$12.90

IMMEDIATE DELIVERY: All orders shipped within two hours. (Sent C. O. D. or remittance in full less 2%.)

Individual parts of kit available separately. We can also supply everything in radio. Write for special prices to Dept. C.

Sold for \$25.00

975

COMPLETE KIT

POSTAL RADIO

135 LIBERTY STREET - NEW YORK, N. Y.

Get Started In Radio

Resident courses in

RADIO SERVICING RADIO OPERATING

Practical instruction on different types of circuits including testing with analyzer, ohmmeter and oscillator. Material supplied. Prepares for government and service examinations. Write for booklet "Opportunities in Radio"

**Educational Department
WEST SIDE Y M C A
7 West 63rd Street, New York**

Makes Your Radio BEHAVE!

Install **AMPERITE**—the voltage regulator recommended by leading manufacturers. Stops burnouts and cracking noises. There's an AMPERITE replacement regulator for every make of radio.

Send \$1.40 to Dept. RC-4 for sample and exclusive territory.

AMPERITE Corporation
561 BROADWAY, NEW YORK

AMPERITE

VOLTAGE CONTROL



... Coming ...

THE FIRST Residence School

In Practical Radio Engineering

Revolutionizing Radio instruction with *personalized* instruction PLUS our usual fine home study course—an opportunity to work with the finest instructors and equipment available—surely an inducement no ambitious radio man can resist.

All interested—Write to ...

Capitol Radio Engineering Inst.

Dept. RC-4

14th and Park Road, N. W.

Wash., D. C.

**SERVICEMEN!
DEALERS!**
YOUR PROFIT
GUIDE
FREE!
EVERYTHING NEW!

Send Today
for this
BIG CATALOG

If you haven't a copy of the RADOLEK 1933 PROFIT GUIDE you are without the biggest and most complete catalog of Radio Merchandise ever compiled by a house catering exclusively to Radio Servicemen and Dealers.

**NEW MERCHANDISE AT
LOWEST WHOLESALE PRICES**

Attach this ad to your letterhead or enclose your business card and mail to

THE RADOLEK CO.
122 Canal Station. CHICAGO, ILL.

CONCOURSE CONDENSERS

highest quality for lowest cost

**Every Type of
Dry Electrolytic
and**

**Wax Paper
Condenser
All Capacities
and Voltages**

To fill every Serviceman's
requirements

Send in your request for our complete
descriptive catalogue

**CONCOURSE
ELECTRIC CO. INC.**
389-409 Wales Ave., N. Y. City

BACK ISSUES of RADIO-CRAFT can be had at the price of 25c each. Address RADIO-CRAFT, 98 Park Place, New York City.

nected across the device to be loaded and the unit adjusted to provide any load value between 0 and 250 watts.

Output Transformers

In connection with using the 30-henry choke and variable resistor in place of the field of the speaker, you will also have to make provision for an output transformer to replace the one which is usually incorporated in the speaker base. Two output transformers are provided on this panel, as shown in Fig. 1D; one is for the pentode tubes and the other is for tubes such as the type 45. You should inter-connect the parts to conform to the connection which the manufacturer of the receiver in question shows for the speaker and output transformer. It is not even necessary to use a dynamic speaker; either a magnetic or dynamic "motor" may be used as connections are provided for both.

If a single output tube is used, then only one-half of the primary of either output transformer is employed; the other half may be disregarded entirely. In this case, a series connection may be employed to prevent the plate current of the power tube from entering the winding of the magnetic speaker. Every Service Man will find upon a little study, that many connections are possible with these two output transformers, the 30-henry choke, and the load resistor.

You will note in Fig. 1D that another A.F. transformer with a ratio of 3 to 1, has been provided on the panel. When you have occasion to work on an older-type receiver and noise is present which you cannot eliminate substitute this tube-to-tube transformer on your panel for the one in the circuit of the receiver. You will find that where A.F. transformers of early design have been in use for several years, corrosion and leakage develop, which causes much noise.

Tuning Coil And Condenser

There is also provided on the panel, as shown in Fig. 1D, a tuning unit consisting of a 245 microhenry coil (about 72 T. No. 24 D.C.C. wire on a 2½ in. form; a 25 T. primary may be wound over this secondary, if desired) connected in parallel with a 350 mmf. tuning condenser. This combination is used in place of the tuning stage of certain receivers where you suspect defects being present and cannot otherwise locate them. (Although extra capacity is introduced in this circuit, by means of the leads from the panel to the receiver, you may, in a large number of cases, compensate for this by connecting a trimmer condenser across the 350 mmf. tuning condenser.) This will enable you to obtain a positive check against the tuning condenser and R.F. transformer secondary coil in the receiver, to determine whether leakage, imperfect contacts, shorts or opens are present. Many other uses for this coil and condenser unit will suggest themselves to the Service Man.

A. F. Amplifier

In the A.F. amplifier section of the circuit, Fig. 1C, a type 27 tube is used in the first stage with push-pull 47's in the last stage. In some receivers you will, for test purposes, want to eliminate the A.F. amplifier entirely, in which case you will use the amplifier unit on the panel, which you will know beforehand is in good condition. This will enable you to get a positive check against the A.F. amplifier section of the receiver on which you are working. The load resistor on your panel is then used across the "B+" circuits of the receiver A.F. system if the tubes have been removed from the circuit. This prevents voltages from rising to abnormal values on the R.F. section of the receiver.

Further uses for the amplifier will be found in connection with a phonograph pickup unit and microphone. The switch which permits the radio set, phonograph and microphone transformers to be coupled to the amplifier is of the two-deck type, and has three movable contacts and one fixed contact for each deck. The switch is turned from position to position depending upon the type of amplification wanted.

Power Supply

The remaining section of the panel is a power supply unit, Fig. 1H. On the primary
(Continued on following page)

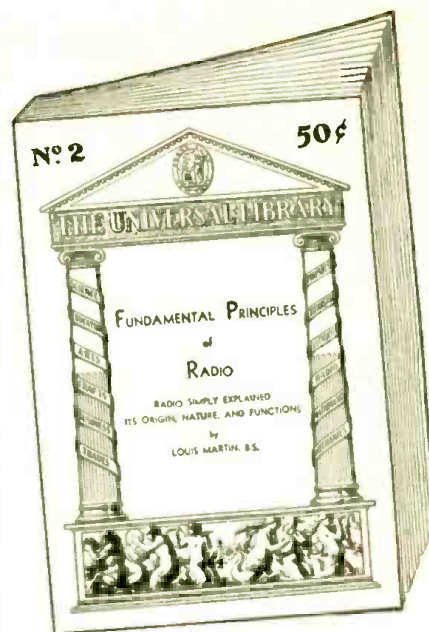

No. 2

FUNDAMENTAL PRINCIPLES OF RADIO

Radio Simply Explained—Its Origin, Nature and Functions
By LOUIS MARTIN

Prepared with special consideration given to young members in the radio profession, and those who have gained their experience in a haphazard fashion, this radio primer is a handy fundamental aid for "checking up" and systematizing your knowledge of radio. Regardless of how much you know about the subject, you should read this book.

PARTIAL CONTENTS:

Chapter I—Fundamentals of Radio: Electricity, Resistance, Batteries, The Magnetic Circuit, The Magnetic Field, Inductance, Condensers, A.C. Circuits, Propagation of Radio Waves; Chapter II—The Simple Radio Set, Single, Two, and Three-Circuit Tuners, The Battery Set, Vacuum Tubes, Electric Sets, Loud Speakers; Chapter III—Diagrams, How to Read Them; Chapter IV—Amateurs and Broadcast Stations, Talking Pictures, Television.

No. 1

FORMULAS AND RECIPES

For the Practical Man
By S. GERNSBACH

An extremely helpful book showing you how to save money by making in your own home, at a fraction of the regular cost, the hundred and one preparations which you now buy for use at home or business.

PARTIAL CONTENTS:

1. Adhesives; Glues; Cements. 2. Cleansing: Stain Removers, Bleaches. 3. Metal Craft: Coloring, Oxidizing, Plating, Polishes. 4. Paints: Colors, Stains, Varnishes. 5. Glass-Work: Cutting, Drilling, Boring, Etching, Engraving. 6. Wood-Craft: Fireproofing, Acid-proofing, Waterproofing, Furniture Polishes. 7. Inks: Sympathetic, Invisible, Holograph. 8. Photography: Developers, Emulsions, Fixers. 9. Antidotes for Poisons. Remedies for Burns and Scalds. Disinfectants. 10. Preparation, Manipulation, Handling, Mixing. Tables of Weights and Measures. Useful Tables.

No. 3

ELEMENTARY MATHEMATICS

for the Technician and Craftsman
By C. SHAINMARK

This manual has been especially prepared for the man who wishes to acquire a working knowledge of the elementary principles of mathematics. A complete treatment of the subject is given by the author, Mr. C. Shainmark, with special attention to the use of mathematics in Radio and other technical work for those who employ its formulas daily.

PARTIAL CONTENTS:

I—Arithmetic: Addition, Multiplication, Subtraction, Division, How to Use Decimals; II—Fractions, Percentages, Ratio and Proportions; III—Powers and Roots; IV—The Metric System; V—How to Measure Surfaces and Volumes; VI—Mathematics for the Manual and Technical Craftsman; VII—Special Mathematics for the Radio Technician; VIII—Commercial Calculations, Short-cut Arithmetic, Interest Calculation, Discounts; IX—Weights and Measures; X—Useful Tables.

All our books are of uniform size, 6 x 9 inches, and contain 64 pages. The books are printed on strong paper with stiff colored covers.

PRESS GUILD INC., 16 Murray St., New York, N. Y.

ANY TWO BOOKS FOR \$5.00 postpaid.
ALL THREE BOOKS FOR \$1.25

Enclosed find \$..... for which mail me postpaid the following books:

No. 1 No. 2 No. 3
Single copy 50c Postpaid

Name

Address

City and State

RC-433

1-Volume RADIO Encyclopedia

Double the size of the
First Edition!

This 2nd Edition, S. Gernsback's Radio Encyclopedia is by far the most useful book in Radio Literature. It is designed for practical use and gives you instant information on everything in Radio.

The fact that 30,000 Radio Men have one or the other edition of S. Gernsback's Radio Encyclopedia in their homes, proves that it is an absolute necessity in the Radio Trade. EVERY RADIO MAN SHOULD OWN THIS VALUABLE VOLUME.

What the New, Second Edition Radio Encyclopedia Gives You

The explanations—or, rather, definitions are not in brief outline form like those of an ordinary dictionary, but they give in fullest detail, and at considerable length, the meaning and application of every word, phrase, general and special term used in the science of radio. Every topic is written in plain, everyday English, easily understood by anyone.

Hundreds of definitions in the book are illustrated by drawings, photographs, diagrams, or charts. Just look up as you would in a dictionary, the word or phrase about which you are seeking information. Every page is key-indexed for convenience and speed in locating any definition. All the subject matter is arranged in alphabetical order.

This greatly enlarged Second Edition Radio Encyclopedia should be used by everyone in radio. It answers all radio questions.—Increases your knowledge and saves time. It covers every known radio problem. It is a gold-mine of facts for every radio man.

**2,201 RADIO DEFINITIONS; 1,253
TECHNICAL ILLUSTRATIONS;
34 TABLES AND CHARTS; 24
PAGES OF APPENDIX; Red Mor-
occo-Keratol Flexible Covers;
Printed on strong ledger paper,
loose-leaf arrangement.**

NEW SELLING PLAN

In order to allow you to inspect the volume and really appreciate what you are buying, we will send it to you with the privilege of inspection. When the express man brings you the book, look it over. If you like it, pay him the purchase price of the book, plus postage. If you do not like it, just tell the express man to take it back. You won't be out one penny.

352 pages
9x12 inches
Weight 3 lbs.



Mail Coupon for this Book!

S. GERNSBACK CORPORATION, RC-433
98 Park Place, New York, N. Y.

Send me one copy of the new Second Edition S. Gernsback's Radio Encyclopedia with the privilege of inspection. If I like the volume, I will pay Expressman \$3.98 plus shipping charges.

Name _____
Address _____
City _____ State _____

side of the power transformer, note that A.C. leads are provided for the turntable used in connection with the phono. pickup unit.

In the filter section of the power pack, a 3-point tap-switch is used to connect (a) a standard, second filter choke into the circuit; (b), the field of the dynamic speaker used with the amplifier or; (c), an extra speaker field (in case it is desired to use an extra speaker for various test purposes), for which binding posts are provided.

A 50,000 ohm bleeder resistor is connected across the output of the power supply to maintain a constant load. Four variable resistors are also included in the circuit so as to give any value of "B+" voltage within the range of the power unit. These "B+" voltages are used for test purposes where a high voltage test is required for supplying voltage to a receiver or to an amplifier.

List of Parts Oscillator

One rheostat, 15 ohms;
One I. R. C. resistor, 10,000 ohms;
One I. R. C. resistor, 400 ohms;
One I. R. C. resistor, 2,500 ohms;
One I. R. C. resistor, 50,000 ohms;
One potentiometer, 5,000 ohms;
One variable condenser, 250 mmf.;
One fixed condenser, .001-mf.;
One fixed condenser, 600 mmf.;
One fixed condenser, 750 mmf.;
One fixed condenser, .002-mf.;
One fixed condenser, .01-mf.;
One fixed condenser, 2 mf.;
One R.F. choke;
One choke coil, 30 hy.;
One Pilot light with socket;
One 4-point switch;
Two toggle switches;
Two 5-hole sockets;
One phonograph pickup matching transformer;
One aluminum shield box, 6x6x9 ins.
One coil form 4 x 2 1/2 ins. in dia.;
One spool No. 30 D.S.C. wire.

Analyzer

Five Yaxley insulated tip-jacks, type 422, J1, J2, J3, J4, J5;
Three I. R. C. .25-meg. resistors, type WW4, R1, R2, R3;
One I. R. C. .15-meg. resistor, type WW4, R4;
One I. R. C. 50,000-ohm resistor, type WW3, R5;
One I. R. C. 40,000-ohm resistor, type WW3, R6;
One I. R. C. 5,000-ohm resistor, type WW3, R7;
One I. R. C. 4,950-ohm resistor, type WW3, R8;
One I. R. C. .505-ohm resistor, type WW4, R9;
One I. R. C. 2.083-ohm resistor, type WW4, R10;
One I. R. C. 33.33-ohm resistor, type WW4, R11;
Two I. R. C. 1,000-ohm resistors, type F1, R12, R13;
Two Yaxley push-button switches, No. 2004L, S1, S2;
One Yaxley push-button switch, No. 2006L, S3;
Two Yaxley Junior jack-switches, No. 760, S5, S6;
Five Yaxley push-button switches, No. 2001L, S7, S8, S9, S10, S11;
Three Yaxley push-button switches, No. 2007L, S12, S13, S14;
One Yaxley 8-point tap-switch, No. 1618, S15;
One Yaxley 2-deck, 4-point tap-switch, No. 1624, S16;
One Yaxley push-button switch, No. 2003L, S17;
One Yaxley 4-point tap switch, No. 1614, S18;
One Na-Ald combination socket, No. 456E, V1;
One Na-Ald 7-hole socket, No. 437E, V2;
One Na-Ald plug, No. 906WLC, with 4-, 5- and 7-prong adapters;
One control-grid clip;
One Weston model 301 "Universal" rectifier-type meter.

Tube Tester

Four 4-hole sockets;
Five 5-hole sockets;

(Continued on following page)

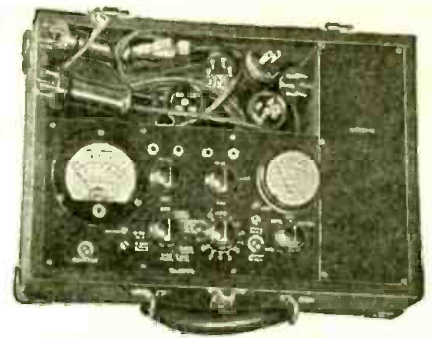

Make More Money with this Better Tester!

Readrite

\$33.00
NET TO
DEALERS
List. \$55.00

Tester No. 1000

NOW you can test automatic volume control, diode, resistance coupling, phase shifting, automatic noise suppression, automatic tone control and the many variations of these circuits. Until this new, exclusively Readrite method appeared, it was necessary to pick your way through the circuits by the laborious and confusing prod contact method. The fact that voltage tests are inadequate and that they lead to gross errors compels testing of modern set circuits by the resistance method.

Quoted at a Popular Price

All parts are carefully assembled in a strong, fine leatherette case with a removable cover. Handy instructions on the panel, show in detail the circuit and tube socket connections for each position of the selector switch.

This precision is quoted at \$33.00 net to dealers—a price so low that you can afford to own it immediately. Besides it will do work that you would not expect from more expensive units.

If your jobber cannot supply you, we will ship the No. 1000 Tester directly to you—when remittance accompanies your order at dealer's net price of \$33.00.

READRITE METER WORKS

47 College Ave., Bluffton, Ohio

MAIL COUPON NOW!

READRITE METER WORKS,
47 College Ave., Bluffton, Ohio

Gentlemen:

Please send me information about Readrite No. 1000 Resistance, Continuity and Capacity Tester. Also catalog of other servicing instruments.

Name _____
Street Address _____
City _____ State _____

It's a ROYAL

A. C. - D. C. MIDGET



Dealers—Here is the latest sensation in Universal Radios—The Royal AC-DC receiver using the latest screen grid tubes, 39 and 36 detector, the new 43 Pentode and the new 25Z5 voltage doubler and rectifier.

The cabinet is only 9 3/4" x 6 1/4" x 4 1/2" deep, in a beautiful walnut finish, and is hand rubbed.

Ideal for homes, offices, studios, dens, camps, etc. It is easily demonstrated and the reception is unusually clear and loud. Satisfaction guaranteed.

Price Complete with **\$9.95**
R.C.A. or Sylvania tubes

ROYAL RADIO INC.
215 West 125 St. New York, N. Y.

RADIO TUBE EXCHANGE OF AMERICA

123 Liberty Street, New York, N. Y.

Dealers have been looking for these features in tubes.

1. A tube that can be sold below list and dealer still realizes a good profit.
2. A tube concern that is reliable.
3. Tubes are boxed in Popular Bright Star Boxes, guaranteed for 3 months.
4. Tubes that were manufactured to sell at H.T.

We offer to the dealers at the following prices:

201A	\$.25	230	\$.39	89	\$.40
112A	\$.35	231	\$.39	56	\$.36
171A	\$.28	232	\$.47	57	\$.34
226	\$.27	233	\$.63	58	\$.34
227	\$.32	232	\$.69	59	\$.30
221A	\$.42	234	\$.50	82	\$.36
235	\$.45	236	\$.51	83	\$.36
245	\$.32	237	\$.42	210	1.00
240	\$.28	238	\$.44	250	1.10
247	\$.45	239	\$.51	281	\$.95

All orders must be accompanied by 20% cash
All tubes sold are RCA Licensed

SERVICEMEN and DEALERS

Radio Service Parts in Stock for all Models of—

General Motors and Dayfan Radios

Specialists in G. M. speaker repairing, Cone and Voice Coll. also field replacements. MAXIMUM charge (on each) \$3.50.

Send for our latest catalog FREE

General Mfrs. Radio Service, 255 7th Ave., New York City

Sensitivity **SHURE** *Tone Quality*
MICROPHONES
TRADE MARK REGISTERED
SHURE BROTHERS COMPANY
Manufacturers—Singers
S. N. SHURE, Pres.
337 WEST MADISON ST. CHICAGO, ILLINOIS

PATENTS TRADE MARKS COPYRIGHTS

"Little Ideas May Have Big Commercial Possibilities"

PROTECT THEM BY PATENTS

Send for our Free book, "How to Obtain a Patent" and "Record of Invention" blank.

Prompt Service—Reasonable Charges—Deferred Payments

HIGHEST REFERENCES

VICTOR J. EVANS & CO.

Registered Patent Attorneys—Established 1898
650 DD VICTOR BUILDING WASHINGTON, D. C.

Be sure to read the announcement on page 616 and 617 which tells about the Consolidated Official Radio Service Manual.

Four 6-hole sockets;
One 7-hole socket;
Seven Yaxley push-button switches, No. 2003L;

One Yaxley 3-point tap switch, No. 1613;
One Yaxley 8-point tap switch, No. 1618;
Two toggle switches;
One pilot light with socket;
One Sprayberry filament transformer;
One R.F. tuning coil, 245 microhenries, L1, L2;

One fixed condenser, .004-mf.;
One resistor, 1,000 ohms;
One resistor, 400 ohms;
Three resistors, 10,000 ohms;
One resistor, 2,250 ohms;
Six control-grid clips.

Pre-Heater

One 2.5-volt step-down transformer, 2.5 V. secondary;

One toggle switch;
One pilot light with socket;
Three 5-hole sockets;
Two 6-hole sockets;
One 7-hole socket.

Tube Short-Checker

One control-grid clip;
One Weston 23-point bi-polar switch;
Two binding posts;
One 4-hole socket;
One 5-hole socket;
One 6-hole socket;
One 7-hole socket.

Condenser Bank

One Flechtheim condenser, 1,000 volts, .05-mf.;
One Flechtheim condenser, 1,000 volts, 0.1-mf.;
One Flechtheim condenser, 1,000 volts, .25-mf.;
One Flechtheim condenser, 1,000 volts, 0.5-mf.;
One Flechtheim condenser, 1,000 volts, 1 mf.;
One Flechtheim condenser, 1,000 volts, 2 mf.;
One Flechtheim condenser, 1,000 volts, 4 mf.;
One Flechtheim condenser, 1,000 volts, 6 mf.;
One Flechtheim condenser, 1,000 volts, 8 mf.;
One Yaxley 9-point tap switch, No. 1619;
Two binding posts.

A.F. Amplifier

One microphone coupling transformer;
One phonograph pickup coupling transformer;
One radio set coupling transformer;
One Yaxley two-deck four-point switch, No. 1624;

Three 5-hole sockets;
Two I. R. C. resistors, 100,000 ohms;
One I. R. C. resistor, 2,000 ohms;
One I. R. C. resistor, 1,000 ohms;
One I. R. C. resistor, 18,000 ohms;
Three fixed condensers, 2 mf.;
Two fixed condensers, 1 mf.;
One push-pull input transformer;
One push-pull output transformer for dynamic and magnetic speakers.

Power Pack

One power transformer for type 80 rectifier;
Two choke coils, 30 hy.;
One dynamic speaker, 1,000 ohms;
One fixed condenser, 4 mf.;
Two fixed condensers, 2 mf.;
Four fixed condensers, 1 mf.;
One I. R. C. resistor, 2 watts, 50,000 ohms;
Four Clarostat variable resistors, 50,000 ohms;
One Yaxley 3-point tap-switch, No. 1613;
Six binding posts;
Two toggle switches;
One pilot light with socket.

Miscellaneous

One push-pull output transformer for type 45 tubes, OT1;
One push-pull output transformer for pentode tubes, OT2;
One A.F. transformer, 3 to 1 ratio;
One heavy-duty choke coil, 30 hy.;
One Clarostat variable resistor, 200 to 100,000 ohms, 250W.;
One 245 microhenry coil;
One tuning condenser, 350 mmf.;
Twenty-three binding posts;
One bakelite panel, 18x30 ins.

MACHINE STETHOSCOPE

Gives inside information on all running machinery

Build it yourself

All you need is an old Flashlight, a SKINDERVIKEN Button and a phone receiver.

Full details of instruction and blueprint showing where and how to listen, also chart indicating character of noise in automobile chassis and motor.

OTHER USES FOR SKINDERVIKEN TRANSMITTER BUTTONS:

RADIO AMPLIFIER PHONOGRAPH AMPLIFIER
DETECTOGRAPH TELEPHONE AMPLIFIER
(Dictograph) LOUD SPEAKER AMPLIFIER
HOME RECORDER CRYSTAL SET AMPLIFIER
LABEL MIKE

16 PAGE INSTRUCTION BOOKLET containing suggestions and diagrams for innumerable uses, furnished with each Skinderviken Button

95c ONLY

Our Microphone Transmitter is the original SKINDERVIKEN Button; it is the smallest microphone made, measuring only 3/8 inches in diameter. It is filled with the finest polished carbon grains obtainable.

—ULTRA SENSITIVE—

USE COUPON—SEND NO MONEY

When the postman delivers your order you pay him for whatever you have ordered, plus postage

PRESS GUILLO, Inc. R.C. 133
16 Murray St., New York, N. Y.

Please mail me at once as many of the following Skinderviken Microphone Buttons as I have indicated.

- One for 95c Two for \$1.75;
 Three for \$2.50 Four for \$3.20

I will pay the postman the cost of the items as specified, plus postage.

Name _____
Address _____
City _____ State _____

In **ST. LOUIS**

THE AMERICAN HOTEL
275 ROOMS WITH BATH
\$2.00 UP

THE ANNEX
226 ROOMS WITH BATH
\$1.50 UP

The **AMERICAN HOTEL** MARKET AT SEVENTH

The **AMERICAN ANNEX** MARKET AT SIXTH

Our Food has made our Reputation
COFFEE SHOP OPEN UNTIL MIDNIGHT

MEGADYNE "N"

(Continued from page 605)

rheostat, R4. The knob for this latter unit is shown as the upper center knob in the panel photograph. Thus, all tuning controls are accounted for.

Connecting the Receiver

With the aid of the pictorial view of Fig. 2, and the rear view of the set, Fig. B, no difficulty should be experienced in the layout of the parts. First, the Fahnestock spring binding posts should be screwed to the 8x10-inch baseboard in approximately the locations shown in the illustration. Next, the tuning condenser, coupler, audio transformer, the two sockets, as well as the radio-frequency choke, R.F.C., and condensers C2, C3 and C5 are mounted in position. Finally, the panel with its vernier tuning dial, the regeneration control, and rheostat should be fastened to the baseboard. The remaining parts are mounted when the wiring is done, and they should be placed as close to their terminals as possible. The choke, R.F.C., should be mounted directly behind the potentiometer on the baseboard for best results.

IMPORTANT. If you use an aluminum panel, Condenser C1 MUST have an insulated (Bakelite) shaft for the rotor plates. The same is true for potentiometer R1. If bakelite panel is used, no shaft insulation is necessary.

The filaments should be wired first. Use only the so-called "push-back" wire, which gives good results, and is easier to handle. Connections are made from the filaments to the rheostat and binding posts as shown in the diagrams. *Solder all joints.*

The three-circuit tuner is then wired, care being taken to connect what is normally the "B" plus terminal of winding "P" to what is normally the "F" terminal of the large coil, the secondary. Connections are then from this coil to tuning condenser, C1, as well as grid-leak and condenser, R2 and C2. The potentiometer, R1, should then be wired into the circuit. The wiring may be completed by connecting the various wires as shown in the picture layout.

After the wiring has been completed, if possible, sleep over it and in the morning, or the next evening, if you wait that long, recheck the circuit connections. Do this by means of a colored pencil to make sure that your connections are right, that nothing has been left out, and that no short circuits have been made.

The wise ones usually find it an excellent idea to test every piece of equipment before inserting it in the set, as frequently a single defective unit will cause the set to become inoperative. The constructor then becomes indignant and writes a long letter to the magazine wanting to know why his set, which was built exactly according to specifications, will not work. I remember a case not so long ago where an indignant reader brought in a Megadyne set described in the July issue which refused to work. After the connections had been checked they were found to be perfect. Just on a hunch, the writer tried a different tube, and the set worked immediately, much to the builder's consternation. It was found that the tube which the builder had used was defective.

Operating the Set

If you remember the first Megadyne set, you know that it had a crystal detector. This crystal was used to obtain additional power, as it was only a single tube set. In the present circuit—a two-tube set—the crystal has been dispensed with. Experiments with the Megadyne "N" immediately disclosed the fact that it was one of the "hottest," if not the hottest, set which the writer ever built. The results obtained with the set herein described far exceed those obtained either with the original Megadyne or with the old "N" circuit. The list of stations received on the loudspeaker by the writer in a single evening in the first part of February on a 30 ft. aerial would seem to verify this statement.

While this set gives loudspeaker results, these results are normally only for local stations, or those within a radius of fifty miles.

(Continued on following page)

THE WHOLE WORLD SPEAKS— Thru

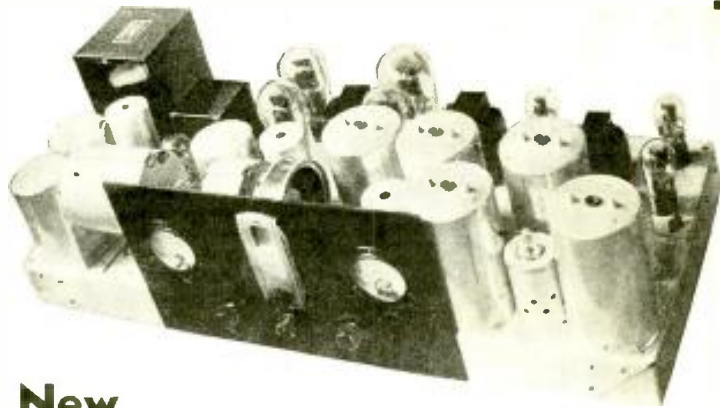

The New ADMIRALTY SUPER-15 MULTI-WAVELENGTH SUPERHETERODYNE

In design and engineering, the world's most advanced Radio Receiver. This great new 16-Tube Model opens up a vast new stage of magnificent entertainment. Dependable long distance reception with the lure of overseas programs via short waves, as well as your favorite broadcasts as they originate at the station. This is the true Romance of Radio that awaits you. The Admiralty Super-15 provides the maximum in sensitivity, selectivity and quality of reproduction ever promised.

Complete literature sent on request. Address

NORDEN-HAUCK ELECTRIC & MFG. CO.

402 Cherry Street, Philadelphia, Pa. U. S. A.

"Builders of the Highest Class Radio Apparatus in the World."

A NEW SERVICE FOR ALL RADIO SERVICE MEN

Here is big news for every Radio Service Man. If you want diagrams of commercial radio receivers, we are now prepared to give you

RUSH SERVICE

In the three OFFICIAL RADIO SERVICE MANUALS published by us so far, we are listing almost 5,000 diagrams of commercial radio sets manufactured in America.

Heretofore, you could get these diagrams only by buying our OFFICIAL RADIO SERVICE MANUALS.

We have, however, had an increasing demand of late from Service Men who are not owners of any of the MANUALS but who wish to get one or more diagrams. We are now prepared to send you such diagrams on a rush order plan. We realize that if you want one of these diagrams *you want it quick.* For that reason, we now have a special staff to send any special diagram to you *the same day that your order is received.*

If you live a distance away from us, and cannot wait for the regular mail, send us 8 cents extra, and the diagram will be sent to you by Air Mail. These diagrams come to you on bond paper, size 9x12 inches. We are prepared to furnish practically any diagram you possibly can ask for—IMMEDIATELY.

HOW TO ORDER

Just tell us what diagram you want, giving us the name of the radio set and model number. It is absolutely necessary for us to have the model number, as without this there is no way of identifying the set. A mere description of the receiver or a list of the tubes it uses is of no help. We will immediately mail you the diagram, if it is available, the same day your order is received. Note: Question coupons are not acceptable for these diagrams.

WE HAVE A UNIFORM CHARGE FOR THIS SERVICE AND THAT IS 25c FOR EACH DIAGRAM

If you wish more than one diagram, the price is still 25c each, but if you order six at one time, the price will be \$1.00 for the six, providing all are ordered at one time.

GERNSBACK PUBLICATIONS, INC.

(Special Diagram Department)

96-98R PARK PLACE NEW YORK, N. Y.

25c

A DIAGRAM

MIDGETS

Mr. Serviceman and Dealer

Midgets of High Quality

- 4 Tube 2 Circuit with tubes.....\$11.00
- 5 Tube 3 Circuit with tubes..... 13.00
- 5 Tube Super with tubes..... 15.50
- 110 Volt, 60 Cycle, A.C.
- 5 Tube Auto-Radio with tubes, dynamic speaker, suppressors (6 cyl.) and B-Eliminator (aerial if specified)\$21.00

Regular 90 day guarantee.

TRUMAN RADIO SHOP

7443-C Stewart Ave. Chicago, Ill.



UNIVERSAL Protected Diaphragm Type 1933 Model "BB"

Damage proof diaphragm protection is now added to the superdependability of Model BB performance. Brand new ahead-of-the-times design. Double-weight, in-built ruggedness. The new 1933 Model BB offers a new conception of what microphone values can be. No advance in prices. Model BB still sells at \$25.00 list.

Universal Microphone Co., Ltd.
424 Warren Lane Inglewood, Calif., U. S. A.

BETTER CONDENSERS AT LOWER PRICES



Yes, and we can prove it! Never was such quality offered in condensers. Never such low prices. Because never were such engineering efforts, new materials, novel production methods and rigid inspection placed behind such products. Dubilier—world's largest and oldest condenser specialist—

free CATALOG

is yours for the asking. Just issued. Covers entire line. Write for your copy today.



DUBILIER
CONDENSER CORPORATION
4377 Bronx Blvd., New York

SERVICE MEN!



Send for our new 1933 Catalog. Just off in replacement parts. Tubes, Batteries, Latest Sound Systems, Automobile Sets and Electrical Supplies, 6000 different items at lowest wholesale prices. Prompt, reliable service. Send for this big FREE Catalog today. You need it.

ALLIED RADIO CORP.
535 W. Jackson Blvd., Chicago, Ill.
Please send me **FREE** your new 1933 catalog.

Name _____
Address _____
City _____ State _____

Here is the INSTRUMENT you have been waiting for! The E33 Tube Checker

Modern in performance—Moderate in price. Tests all tubes without adapters, 4, 5, 6 and 7 prong, giving Short Test; Grid Check Test; Oscillation Test and Total Filament Emission Test. Voltage regulation 90-130 volts. Nine sockets and selector switch gives flexibility that takes care of all present and future type tubes. Simple to operate—Material and workmanship guaranteed. Lettered backelite panel—Imitation leather carrying case with handle provided—Light and portable.



ONLY \$19.80

ORDER DIRECT OR WRITE FOR TRIAL OFFER.

L. & L. ELECTRIC COMPANY
336 Madison Ave. Memphis, Tenn.

TAU-REX CONVERTS

Any D. C. Milliammeter into a Sensitive A. C. Meter. A New Meter Rectifier—MADE FOR METERS—Size 1/4 in. by 3/8 in. FULLY GUARANTEED. Can be used to test testers, analyzers and for many other purposes. See Jack Grand's article, "The Specialty Tester" in the November issue of Radio-Craft. TAU-REX will be shipped postpaid promptly upon receipt of \$3 (check or money order)—or order C. O. D. and pay postman. Furnished Complete with Diagrams and Instructions. Leo Taussig, 3245 37th St., Long Island City, N. Y.

While I have been able to receive stations as far as Des Moines on the loudspeaker, I should not, in all fairness, call this loudspeaker reception, because the volume was not enough to fill a room comfortably; but, nearer stations, such as KDKA, Pittsburgh; WHAS, Louisville; and WTAM, Cleveland, came in with fair loudspeaker volume on a 30-foot aerial. In good locations, it may be possible to bring stations in on the loudspeaker much more distant than these with good volume. However, for the really distant stations, headphones should be used. As for the loudspeaker, any good magnetic speaker can, of course, be used; the present set, being battery operated, is not adapted for dynamic loudspeaker use.

Start the receiver by connecting the batteries and headphones; the loudspeaker may be used after the set has been adjusted properly; but, of course, you will use an aerial and a ground for maximum results. The set is so remarkably sensitive that I could not use an aerial longer than 30 feet, and this particular aerial was not on the roof either, but ran parallel to a number of windows on the outside of the apartment, right on the window-sill, which is not good antenna practice. With a good aerial, of course, results will be much better. As stated before, if you have an aerial longer than 50 feet, then it becomes necessary to use the small postage stamp condenser in the aerial lead, marked C4.

If everything has been connected right, and the tickler is in the right position (wrong position when upside down), then immediately you should hear loud squeals in the headphone receivers as you turn the main tuning dial. If you hear no squeals, the set is not oscillating; the reason, first, is that the tickler may be turned in the wrong position; second, the potentiometer is not adjusted right, or third, the filament control is wrong. You will quickly find, that the filament rheostat is critical, and the set will oscillate wildly if the filament rheostat is in a certain position. By making the filament glow brightly, oscillation will stop, and the set will not function normally.

You will find that the set works better when the filaments are just barely red. If the set is oscillating violently, tune the set to the loudest whistle on the dial, and then manipulate the potentiometer very slightly until the station clears up.

Locals should come in with terrific volume if all adjustments are right. Adjust the potentiometer in such a way that the squeal just disappears; then the sound of music or voices from the broadcast station will come in as clear as a bell. If you cannot clear a station, it means that the set is still oscillating too strongly, and you must turn up your rheostat, making the filaments brighter; this usually clears every station.

Never touch the tickler of the loose coupler once the set is working normally. Use the main tuning condenser control, and for oscillation control use the filament rheostat as well as the potentiometer.

Adjusting the Parts

An adjustment of the various parts may best be made by tuning in a station at about the middle part of the dial, say around 50. Then tune in a station at the low end and repeat the adjustment. So far, I presume you have only tuned in the locals. The distant stations are tuned-in in exactly the same manner, except that the controls are somewhat finer. A faint whistle on the dial may be cleared by means of the potentiometer and rheostat, and a very careful adjustment, if necessary, by readjusting the main tuning condenser control. You must hit the whistle exactly in the center, because at either end you will get distortion. For that reason, fine adjustment of the main tuning condenser control on distant stations is absolutely essential.

You will find, in some locations, that you will be able to bring in the locals without aerial or ground. As a matter of fact, you can build a portable and bring in the locals on the headsets without much trouble. If an aerial is needed, you can attach a wire to your wrist, which will give you additional volume; the wrist connection is, of course, attached to the aerial binding post. In some

(Continued on following page)

There's only

ONE WORLD-WIDE Radio Magazine

Published Today



25c The Copy

EUROPEAN radio publications are abounding with new circuits and radio developments that find their way slowly over to the United States. The reason is that there is such a tremendous amount of original radio engineering going on in this country, there has been no publication which catered to the foreign developments. American radio publications must report the American activities first and, as a rule, have no room left for what is going on in Europe.

Mr. Hugo Gernsback conceived the idea of publishing a totally different radio publication and the result is RADIO REVIEW AND TELEVISION NEWS.

This is not entirely a new magazine; it is, really, two magazines in one. A section devoted to television has been retained, and which will report in every issue, the major American and European television advances; but the big, front section is given over to an international radio digest. This magazine, therefore, will perform the function that, for instance, the LITERARY DIGEST is serving in literature. You may not be aware of the fact that there are some 160 radio publications printed outside of the United States; but from all of these publications RADIO REVIEW is extracting the best.

RADIO REVIEW AND TELEVISION NEWS shows you what is going on in radio all over the world. It gives you hundreds of new radio hook-ups, special circuits, new time-saving kinks, new money-making ideas galore. You will find here the latest radio circuits and sets from France, Germany, England, Italy, Russia, Norway and even Japan.

Dozens of translators make each issue a memorable one.

Features of the Current Issue:

- Build Your Own "Theremin" Electric Musical Instrument
 - A Band Pass Filter to Improve Receiver Selectivity
 - Complete Crystal Receiver in a Tobacco Can
 - Modern Tuning Coil Practice
 - Hints on Tone Correction
 - The Screen Grid Tube as a Detector
 - Matching the Load
 - Notes on Gank Tuning
 - The "Volume" Speaker
 - Radio Kinks
 - Review of American Radio Magazines
 - Digest of Radio Patents
- Also: enlarged television section containing numerous circuits and operating hints.

Clip and Mail Coupon Today!

RADIO REVIEW AND TELEVISION NEWS
98 Park Place RC-4
New York City (Mark X in Square Which Offers you Desire)

Gentlemen:

As per your special offer, I enclose \$1.25 (Canada and Foreign \$1.50) for which enter my subscription to RADIO REVIEW AND TELEVISION NEWS for one year.

Send me the current issue of RADIO REVIEW AND TELEVISION NEWS, for which I enclose 25c (U. S. stamps or coin accepted) with the full understanding that if I do not like the magazine you will refund the money.

Name _____
Address _____
City and State _____

CLASSIFIED ADVERTISEMENTS

CHEMISTRY
BECOME A TRAINED CHEMIST. Thousands of opportunities—fascinating career. Learn at home. Complete experimental laboratory outfit given. Write for big free book. Chemical Institute, 19 Park Place, Dept. RC, New York.

DOGS

BEAUTIFUL Registered bull pups, \$15. Bulldogs. 501-RC, Rockwood, Dallas, Texas.

INSTRUCTION

CANADA'S Oldest and best equipped radio school offers complete course covering Radio, Television, Sound Amplification, etc. Approved by leading radio manufacturers. No duty or exchange to pay. Radio College of Canada, Limited, 310 Yonge St., Toronto.

GOVERNMENT JOBS. \$105—\$191 month. Men—Women, 18-50. Qualify for future vacancies. Common education. 25 coached FREE. Write immediately. Franklin Institute, Dept. H77, Rochester, N. Y.

INVENTORS

PATENTS—SMALL IDEAS may have large commercial possibilities. Write immediately for free book, "How to Obtain a Patent" and "Record of Invention" form. Delays are dangerous in patent matters. Free information on how to proceed. Clarence A. O'Brien, 533-C Adams Building, Washington, D. C.

RADIO

MAGNETIC Speakers rewound and adjusted, \$1.25. Radio Service, Flora, Indiana.

GUARANTEED "Pocket Radio," \$2.00. Catalog, 10c. Neil Tasker, Shamokin, Pa.

FOR SALE—Ford Model A Sound truck with A.C. Equipment. Cost \$1200, will sell for \$350. Write Box 201, Ambridge, Penna.

QUICKEST, Latest radio analyzer, built simple. Always correct for all prong arrangements. Blue prints, 40 cents (coin). Eradio Laboratory, 354 Burncoat, Worcester, Mass.

TRANSFORMERS REWOUND, varnished, baked, guaranteed, reasonable cost. **SPEAKER REPAIRING,** magnetic \$2.00-\$2.50; dynamic, voice coils, fields, etc., reasonable charges. Clark Bros. Radio Co., Albion, Iowa.

TRANSFORMER And Speaker Field coils re-wound or made to order. Transformer and complete instructions on rejuvenating of AC tubes \$4.00 postpaid. 5 hours service. Pemberton Laboratories, 921 Parkview, Fort Wayne, Indiana.

GUARANTEED MICROPHONE REPAIRS— Any make or model—24 hours service. Stretched diaphragm double button repairs, \$7.50. Others, \$3.00. Single button repairs, \$1.50. Write for 1933 Catalog with diagrams. Universal Microphone Co., Ltd., Inglewood, Calif.

HELLO AMERICA!!

IT'S HERE!

NEW YORK'S MOST SENSATIONAL

Cabaret Restaurant

FEATURING

JAMES HALL

(Movie Star of Hell's Angels)
AND HIS MARDI GRAS ORCHESTRA
 Dine in an Atmosphere of Far Away Monte Carlo While You Enjoy Bobby Sanford's
WHEEL OF DREAMS

Broadway's Smartest Floor Show With a Host of Popular Favorites and
40—GORGEOUS GIRLS—40

Phone Anyone—Anywhere from the Telephone On Your Table
DINNER—\$1.50

Monte Carlo Casino

48th Street West of Broadway
 Reservations—Lackawanna 7111
NO COVER CHARGE EVER

locations, if you are only interested in locals, a ground connection is all that is required.

IMPORTANT

Not all type 32 tubes work alike. While I specify a "B" plus voltage of 67½, which is the connection that goes to the choke and the screen-grid, there are some tubes which will not stand this much voltage. When you first connect this set, be sure to look carefully at the tube. **IF YOU SHOULD SEE THE GRID (NOT THE FILAMENT) QUICKLY REDDEN, IMMEDIATELY DISCONNECT THE 67½ VOLT LEAD,** because if you do not, the grid of the tube will burn out. This is peculiar to the Megadyne connection. If, therefore, the grid begins to get cherry red, use only 45 volts, which will be found sufficient. Even if the grid does not redden, you might try the 45-volt connection, because with some tubes, 45 volts works better than 67½. In many cases, 45 volts will bring in stations louder than 67½.

With certain tubes condenser C1 and grid leak R2 can be shorted or left out entirely, with added volume resulting. Try it.

Once you have mastered the controls, which should not take you more than half an hour, you will find it easy to control the oscillations, and bring in practically every station in the country; and you will be well rewarded for the time spent in constructing the set.

The circuit has excellent possibilities, and I am sure that builders all over the country will find it profitable to build this set.

List of Parts

- One Gen Win three-circuit tuner, as described;
- One Hammarlund variable condenser, type ML23, .0005-mf., C1 WITH INSULATED SHAFT);
- Two Flechtheim fixed condensers, type MC, .00025-mf., C2, C5;
- One Flechtheim tubular condenser, .01-mf., C3;
- One Hammarlund postage stamp condenser, 50 mmf., C4 (optional);
- One Acratet potentiometer, type 6185, 20,000 ohms, R1; (WITH INSULATED SHAFT);
- One I.R.C. grid leak, 1 watt, 7 megohms, R2;
- One Acratet coupling resistor, type 3500, .5-meg., R3;
- One 20-ohm rheostat, R4;
- One Thordarson audio transformer, A.F.T.;
- One Blan R.F. choke, 10 millihenry, consisting of 500 turns of No. 30 S. S. C. wire wound on a spool ¼ inch in diameter and ¼ inch wide, R.F.C.
- One Eby four-prong socket, V1;
- One Eby five-prong socket, V2;
- Eight Fahnestock binding posts;
- One National midget dial, 0-100-0;
- One National shur-grip screen-grid clip;
- One Blan aluminum panel, 7x10 inches;
- One baseboard, 8x10x¼ inches;
- Three small black knobs;
- One type 32 tube;
- One type 33 tube;
- Two No. 6, 1½-volt dry cells;
- Two 45-volt "B" batteries.
- Miscellaneous nuts, bolts, wire, etc.;

READERS' DEPARTMENT

(Continued from page 614)

test is completed.

Plug the receiver under test into A.C. outlet No. 1 only, as this outlet has a pilot light to remind you not to make continuity tests in the receiver until the current is turned off. The other A.C. outlets are alive at all times, and are convenient for a soldering iron, A.C. dynamic reproducer, oscillator, etc.

On those sets where it is not possible to get at the tube socket prongs with the test prods, we disregard the control-panel and simply use the Weston cable and plug (which is also used to get milliammeter readings).

Besides the highly professional appearance that is obtained from the above combination of Weston model 547 and control-panel, various tests can be made rapidly without tedious changing of the test prods' connections which are necessary when using the Weston instrument alone.

PAUL G. FREED,
 Freed Radio Co.,
 5053 Baltimore Ave.,
 Philadelphia, Pa.

(Continued on following page)

RCA INSTITUTES

Recognized Standard in Radio Instruction Since 1909

Technical training courses in radio and associated electronic arts.

SOUND TECHNICIANS COURSE embracing Television Fundamentals, Public Address Systems, Recording, Sound Motion Pictures, Electronic Tube Applications.

BROADCAST TRANSMISSION in all its aspects including Studio and Control Room Operation.

RADIO SERVICING including Broadcast Receivers, Home Talkies, Rudiments of Television.

RADIO OPERATING—Aircraft, Marine and Police Alarm Systems.

New General Course includes the several phases of radio and associated arts.

Resident Schools at **NEW YORK and CHICAGO**

EXTENSION COURSES for HOME STUDY under new "no obligation" plan, with privilege upon graduation of 2 weeks' intensive practical training without charge at either Resident School.

Mail Coupon for Illustrated Catalog.

RCA Institutes, Inc.,
 Dept. RT-4
 75 Varick Street, New York, N. Y.
 1154 Merchandise Mart, Chicago, Ill.

Please send with no obligation to me:

Full information on the New General Course in Radio.

Illustrated catalog and information about specialized resident school courses in radio and allied arts.

Information about extension course for study at home, together with illustrated catalog.

Name..... Age.....

Address.....

City..... State.....

AERO INTERNATIONAL ALL WAVE 11-TUBE SUPER-HETERODYNE DE LUXE



Completely Assembled With 2 Matched Full Dynamic Speakers **\$29.75**

At last! World wide reception at a sane price. 15 to 550 meters. Besides the regular broadcast band, it brings in foreign programs, amateurs, police calls, ships at sea and aeroplanes. One dial control. No plug in coils. Latest super-phonics tubes.

AERO 4-TUBE MIDGET

\$10.95 less tubes
 tubes \$2.95



The lowest priced quality Midget Receiver on the market today. Very selective, brings in long distance like local stations.

AERO 5-TUBE MIDGET \$11.90
 AERO 6-TUBE SUPERHET-ERODYNE MIDGET \$18.50

AERO WORLD WIDE

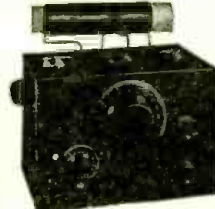

1-Tube SHORT WAVE SET for Head-Phone Operation **\$5.95**

Listen in DIRECT to London, Paris, Berlin, Buenos Aires and other broadcasting stations throughout the world via short waves. Your ordinary receiver cannot tune in these low wave stations. **WORLD-WIDE RECEIVER** gets 15 to 500 meters. Aero 2-Tube Short Wave Set \$8.75. The same as above set but it has 1 stage of Audio Frequency added to it.

Write today for your FREE copy of our CATALOGUE

CHARLES HOODWIN CO.

4240 Lincoln Ave., Dept. D-150 Chicago 633

USEFUL RADIO BOOKS WHICH EVERY EXPERIMENTER NEEDS IN HIS LIBRARY

There is not a radio man in the field, experimenter, service man or dealer, who will not want to read these two books. Right up to the minute with outstanding developments in short-wave radio—new methods and apparatus for quickly learning how to become a practical radio operator. Each book is authoritative, completely illustrated and not too highly technical. The text is easily and quickly grasped.

How to Become An Amateur Radio Operator

We chose Lieut. Myron P. Eddy to write this book because his long years of experience in the amateur field have made him pre-eminent in this line. For many years he was instructor of radio telegraphy at the R.C.A. Institutes. He is a member of the I.R.E. (Institute of Radio Engineers), also the Veteran Wireless Operators' Association. If you intend to become a licensed code operator. If you wish to take up phone work eventually, if you wish to prepare yourself for this important subject—this is the book you must get.

Partial List of Contents

Ways of learning the code. A system of sending and receiving with necessary drill words. Is supplied so that you may work with approved methods. Concise authoritative definitions of radio terms, units and laws, brief descriptions of commonly used pieces of radio equipment. This chapter gives the working terminology of the radio operator. Graphic symbols are used to indicate the various parts of radio circuits. General radio theory particularly as it applies to the beginner. The electron theory is briefly given, then waves—their creation, propagation and reception. Fundamental laws of electric circuits, particularly those used in radio, are explained next and typical basic circuits are analyzed. Descriptions of modern receivers that are being used with success by amateurs. You are told how to build and operate these sets. Amateur transmitters. Diagrams with specifications are furnished so construction is made easy. Power equipment that may be used with transmitters and receivers, rectifiers, filters, batteries, etc. Regulations that apply to amateur operators; the International "Q" signals, etc.

How to Build and Operate Short Wave Receivers

is the best and most up-to-date book on the subject. It is edited and prepared by the editors of *SHORT-WAVE CRAFT*, and contains a wealth of material on the building and operation, not only of typical short-wave receivers, but short wave converters as well.

Dozens of short-wave sets are found in this book, which contains hundreds of illustrations; actual photographs of sets built, hook-ups and diagrams galore.

The book comes with a heavy colored cover, and is printed throughout on first class paper. No expense has been spared to make this the outstanding volume of its kind. The book measures 7 1/2 x 10 inches.

This book is sold only at such a ridiculously low price because it is our aim to put this valuable work into the hands of every short-wave enthusiast.

We know that if you are at all interested in short waves you will not wish to do without this book. It is a most important and timely new radio publication.

**Each Book Contains Over 150 Illustrations
72 Pages 7 x 10 inches Not Sold on Newsstands**

Mail Coupon at Left for Books!



50¢ EACH

SHORT WAVE CRAFT
96-98RC Park Place,
New York, N. Y.

Gentlemen: I enclose herewith \$..... for which please send me, prepaid a copy of the book checked.

- () HOW TO BUILD AND OPERATE SHORT-WAVE RECEIVERS—50c.
- () HOW TO BECOME AN AMATEUR RADIO OPERATOR—50c.

Send money order, check, cash or new U. S. stamps. Register letter if it contains stamps or currency.

Name

Address

City State

REFRIGERATORS!

SERVICE ELECTRIC

In your community there are dozens of electric refrigerators to be serviced. Many need immediate repairs which can be made quickly, with little expense—and which you can repair with the aid of this authoritative Refrigeration Service Manual. Make many extra dollars, together with other repair work, electric refrigeration servicing is a well-paying business—start in your spare time—before long you will devote full time to it. One or two jobs pays the small cost of the OFFICIAL REFRIGERATION SERVICE MANUAL.

**96 Pages of New Data
Have Been Added to the
OFFICIAL REFRIGERATION
SERVICE MANUAL**

To bring this useful service manual right up-to-date, Mr. L. K. Wright, the editor of the OFFICIAL REFRIGERATION SERVICE MANUAL, has added a wealth of material on new electric refrigerators and older models as well. As usual every refrigerator has been accurately described from the viewpoint of servicing—diagrams to illustrate the essential parts, so simplified that anyone can make the repairs. The addition of these new pages will not increase the cost of the book to those who order their copy now.

Here Are Some of The Important Chapters:

- Introduction to the Refrigeration Servicing Business.
- History of Refrigeration.
- Fundamentals of Refrigeration.
- Description of All Known Types of Refrigeration.
- Motors.
- Trouble Shooting.
- Unit Parts, Valves and Automatic Equipment.
- Makes and Specifications of Units, Manufacturers of Cabinets, Refrigerants and Automatic Equipment and Many Other Important Chapters.

**OVER 1,200 DIAGRAMS
450 Pages
Flexible Looseleaf Binder
Complete Service Data**

Mail Coupon Today!



GERNSBACK PUBLICATIONS, Inc. RC-133
96-98 Park Place, New York, N. Y.

I enclose herewith my remittance for \$5.00 (check, stamps or Money Order accepted) for which you are to send me, postage prepaid, one copy of the OFFICIAL REFRIGERATION SERVICE MANUAL, together with the extra 96 pages of new material at no extra cost.

Name

Address

City State

DID YOU SAY BARGAINS?

THAT'S WHAT I SAID BARGAINS!

Publisher's Samples and Bindery Rejects

We have on hand a few hundred copies of the **SECOND EDITION, S. GERNSBACK RADIO ENCYCLOPEDIA**, which we are going to sell as quickly as possible at a marvelous bargain price.

We are going to call it a sale of "shop-worn" books. These books are actually, however—every one of them—new books, and for all practical purposes as good as any you could buy. They are copies that have been used by the publisher as display and salesman's samples, as in bookstore windows, exhibitions, etc. Some were set aside because of bindery imperfections, such as a slight defect in the gold-stamping, or a small irregularity in the texture of the cover—most of these blemishes being so slight as to be scarcely noticeable on ordinary inspection. The text pages are perfect. The books are not in any way marred, but merely not fresh enough to be sold as new books.

This Second Edition Radio Encyclopedia consists of 352 pages, weighs 3 lbs., bound in red Keratol flexible binder, size 9x12", contains 2,201 Radio Definitions, 1,253 tech. illustrations, and 34 tables and charts.

We are disposing of these very fine books at the ridiculously low price of

\$2.00 per copy

New books of regular stock are selling currently at \$3.98. This offer of course will hold only so long as our special stock holds out—first come, first served!

We have also on hand a few hundred remaining copies of the unbound volumes of the **FIRST EDITION** of this encyclopedia, which we have been selling out very rapidly, at the close-out price of

69 cents a copy

The size of the book is 9 by 12 inches. It contains 168 pages, and is printed on the finest book paper obtainable, it contains over 1,930 definitions, 549 photo reproductions, drawings, and diagrams.

Don't send any money. Delivery will be made to you on the following plan:

ISKOR PRESS, Inc., 19 Park Place, New York, N. Y. RC Please send me

- SECOND EDITION, S. Gernsback Radio Encyclopedia**, of your special "shop-worn" sale lot, at **\$2.00**
- FIRST EDITION, S. Gernsback Radio Encyclopedia**, of your unbound special lot, at **69c**

I will pay the postman the amount indicated above on delivery of my order, plus the small postage charge.

Name

Address

City State

EXPERIMENTAL SHORT-WAVE COIL

Editor, RADIO-CRAFT:

I wish to offer the following suggestion to your short-wave fans:

I had quite a time getting my short-wave coils to operate using what information I could get as to the number of turns for the desired band, so I made up from junk the coil illustrated in Fig. B, and used it to find the correct number of turns. I find this to be a very slick scheme. Just wiggle the two bus-bar levers until best operation is obtained on the desired band, and then count the number of active turns in each coil.

JOSEPH EBY,
Route No. 7,
Dayton, O.

CHANGING TESTERS

(Continued from page 603)

back of the panel, which also contains room for a flashlight, screw-driver, socket wrench, pliers, etc., in addition to the accessories supplied with the analyzer. These accessories include a pair of long insulated solderless test probes with pointed steel terminals, a pair of short insulated test lead conductors, output meter adapters for 4-pin, 5-pin, 6-pin and 7-pin power tubes, four snap-catch 6-hole analyzer plug adapters for 4-pin, 5-pin, large 7-pin and small 7-pin tubes and complete operating data for all applications of the analyzer.

Instead of re-manufacturing old testers into the Model 401 analyzer described above, these instruments may be converted into the Supreme Model 400-C Meter Unit for use in conjunction with an Analyzer Converter such as the Supreme model 77, or for use with a "meterless tube checker" such as the Supreme model 62. To these may be added, in combination carrying cases, a suitable oscillator, such as the Supreme model 60, or a decade box, thereby giving the radio Service Man his choice of other needed equipment in convenient and economical arrangements.

While the modernizing process outlined here applies particularly to the changes involved in converting a model 400-B into a model 401, the re-manufactured instrument would be nearly identical even if made over from old Jewell patterns 199, 408 and 409; old Weston model 537 and 547; and other old Supreme models such as the 99-A or 400-A. Of course, there may be slight differences in the meter ranges. Thus, the analyzers, re-manufactured from old Supreme Diagnostics have D.C. voltmeter ranges of 0/10/100 250/1000 volts. Those made from the Model 537 set testers have 0/8/120/300/600-volt ranges. No change is made in the 0/7.5/75/300/600-volt ranges of the Jewell pattern 199, but the readability of the dials is improved by the addition of a 60-division arc for the 0/300/600-volt ranges. As regards the D.C. milliamperes ranges, these are 0 to 10, 0 to 100, and 0 to 250 milliamperes, in the case of re-manufactured instruments. A high range of 0 to 300 milliamperes is added to the D.C. meters of Jewell pattern 199 and the Weston model 537 Set Tester.

While it is possible for the Service Man to obtain the correct multiplier resistors for the multi-range voltmeter, for the added ohmmeter circuits, and the proper shunt resistors for current measurements, it should be kept in mind that the internal meter resistance and milli volt values of the old meters must be accurately determined before the resistor values can be calculated. Unless facilities are available for measuring these values, it is far better to have the re-manufacturing done by specialists who are entirely familiar with the problems presented in each particular job to be modernized.

Beginning With This Issue—

A department especially conducted for the beginner in radio. In the department will be described simple but effective receivers that may be constructed by almost anyone. See page 604.

THE NEW TUBES

(Continued from page 588)

rectifier of the heater-cathode type designed for operation in circuits delivering D.C. power directly from an A.C. power supply. Its structure is simple, rigid and compact, and its characteristics are such that it gives very efficient rectification.

The following rating and characteristics obtain: Heater voltage, 12.6 volts A.C. or D.C.; heater current, .3-ampere; A.C. plate voltage (R.M.S.), 230; D.C. load current, 60 ma.

INPUT VOLTS, 115 R.M.S.

D.C. Load Current Milliamperes	D.C. Volts at Input to Filter 8 mf. Filter	10 mf. Filter
15	141	145
20	134	140
30	120	129
40	106	118
50	93	109
60	83	101

INPUT VOLTS, 123 D.C.

15	120	120
20	120	120
30	119	119
40	118	118
50	117	117
60	116	116

This rectifier is especially suitable for use in "universal" type receivers which are designed for both A.C. and D.C. operation. Such receivers usually employ four or five tubes of the heater type, and require a total plate current of 30 to 40 milliamperes. The heaters of all the tubes, including the rectifier, are operated in series. This automatically imposes the requirement that the filament current rating be the same for all the tubes. The 12.6 volt heater in the 12Z5 reduces, somewhat, the heat dissipation in the fixed series resistor in the heater circuit. No power transformer is necessary in a receiver of this type and the rectifier tube remains in the circuit for either A.C. or D.C. line service.

In order to obtain a high D.C. output voltage, a filter of the condenser-input type should be used, 16 mf. being recommended for half-wave rectification. Condensers having a moderate voltage rating will suffice because the input peak voltage of the A.C. supply is relatively low.

The base pins fit the standard four-contact socket which may be mounted either in a vertical or in a horizontal position, the former being recommended. The base connections are as follows (looking at the base from the bottom, and going in a clockwise direction from the left heater pin): heater, plate, cathode, heater.

The 25Z5: New Rectifier-Doubler Tube

The 25Z5 is a full-wave high vacuum rectifier of the heater-cathode type for use in suitable circuits designed to supply D.C. power from an A.C. power source. This tube is of particular interest because of its adaptability to the design of "transformerless" receivers of either the "universal" type or the more conventional A.C. operated type. For use in the "universal" or A.C.-D.C. types of receivers, the 25Z5 may be employed as a half-wave rectifier, while in the strictly A.C. operated type, it may be used as a voltage doubler to provide about twice the D.C. output voltage obtainable from the half-wave arrangement. This twofold application is made possible by the use of separate pin connections for each cathode—there is one cathode for each half-wave arrangement.

The heater of this tube has been designed in order to facilitate its economical operation in series with the heaters of other tubes in the radio set. The employment of a 25-volt heater in this 25Z5 permits the construction of a receiver having reduced heat dissipation in the fixed series resistor which is almost always required in a series type filament connection.

The voltage-doubling property of this tube will now be considered in more detail:

In rectifying circuits using tubes, current flows between cathode and plate only during the time when the voltage on the plate is positive. Such circuits, in their simplest form, employ a single diode which rectifies the A.C. supply on alternate half-cycles. The output of a single diode consists of uni-directional pulses of current and voltage. These pulses may be smoothed by means of a suitable filter. If two diodes are employed, each half-cycle of the A.C. supply may be rectified. The conventional circuit using two diodes is known as a full-wave rectifier. The features of

such a rectifier in comparison with a half-wave rectifier are: approximately twice the output current with essentially the same D.C. voltage output; and more economical filtering due to the doubled frequency of the output pulsations.

In comparison with the full-wave connection, another arrangement of two diodes is of interest. In this case, two diodes, one of which is reversed with respect to the other, are connected to two condensers as shown in Fig. 9. This arrangement provides rectification of each half-cycle of the A.C. supply. Furthermore, during the period that one diode is rectifying, the condenser across the other diode is discharging through the load and the conducting diode. As a result, the voltage across the load is the sum of the D.C. output voltage of the conducting tube and the discharge voltage of the condenser. The total D.C. voltage across the load, therefore, is approximately twice the D.C. voltage obtainable from a half-wave rectifier. For this reason, this circuit is known as a voltage-doubler. Like the full-wave circuit, the doubler circuit gives an output having a ripple frequency twice that of the supply line.

In the design of a voltage doubler using this circuit, large capacitances are necessary to give good regulation of the D.C. output at higher values of load current. A point of interest to the set designer, however, is that the voltage rating of these condensers is determined not by the D.C. output voltage, but by the peak value of the A.C. supply.

Figure 10 shows the external characteristics and circuit diagram of the 25Z5 when used as a half-wave rectifier, the purposes for which were explained above. The socket connections for this tube are illustrated in Fig. 11.

The following rating and characteristics obtain: Heater voltage, 25; heater current, .3-ampere; R.M.S. plate voltage per plate, 125; D.C. load current, 100 ma.

The 84: High-Vacuum Rectifier

The 84 is a full-wave high-vacuum rectifier with a 6.3-volt heater. It is designed especially for use in automobile "B" supply units. The heater-cathode design permits a close electrode spacing providing high efficiency of rectification and fulfills the requirements of a rigid, compact structure so desirable for automobile service.

The rating and characteristics of this tube are as follows: Heater voltage, 6.3; heater current, .5-ampere; A.C. volts per plate, 225 R.M.S. max.; D.C. load current, 50 ma. max.; voltage between heater and cathode, 300 D.C., max.

The use of the 84 in "B" voltage supply units for automobile radio equipment is highly recommended. Designed to permit a voltage difference between heater and cathode of 300 volts D.C., the rectifier may be operated from the same "A" battery as the set tubes.

In order to obtain satisfactory output and regulation careful consideration should be given to secure proper filtering. Filter circuits of the condenser-input or the choke-input type are applicable.

The D.C. output will be considerably greater with a condenser input filter than when the other type is used. Also, it will be true that higher peak plate currents are to be encountered. The first condenser in the filter circuit, therefore, should not have too large a capacity. It is not likely that the A.C. input voltage will be sinusoidal in wave form so that the instantaneous peak values may be considerably greater than 1.4 times the R.M.S. value. The voltage ratings of the condensers must be such as to handle the maximum peak values encountered.

To adapt the 84 to half-wave circuits it is only necessary to tie the two plates together at the socket, so as to form a single element.

This tube fits a standard 5-prong socket. The heater terminals are normal, the cathode terminal is normal, and the remaining two terminals connect to the two plates in the tube.

In Our Next Few Issues:
A New Ohmmeter and Voltmeter
Rewiring Sets for 2-volt Tubes
More Information on the
TRAUTONIUM

This E. & H. Set-Tested

AERIAL ELIMINATOR



Fits inside radio cabinet. Size 1 1/2 x 4 inches—equals average 75-ft. aerial. 50 ft. high. Installed by anyone in a moment. No light socket connection or current used. Eliminates poles, wires, lightning hazards. More sensitivity and volume on all stations. Each tested on 1127-mile reception. Used in U. S. Hospitals. Order now for greater radio satisfaction. Shipped post-paid under three-day trial on money-back guarantee. Send \$1.00 bill, check or M.O. or sent C. O. D. if preferred. Send this ad with your order. If interested in our sales proposition check here.

Complete POSTPAID

F & H Radio Laboratories, Dept. 44, Fargo, N. D.

M-I-L-E-S

Lapel Microphones

at NEW LOW PRICES!

Lapel Microphones introduced by Miles gained national prominence at political conventions. NOW they are obtainable for all forms of public address work, inter-office communications, etc. Exclusive Miles carbon buttons and alloy diaphragms make these Lapel "Mikes" super-sensitive.



DOUBLE-BUTTON LAPEL MIKES

Heavy duty 2-button microphones for all purposes. \$2.94 \$4.41 \$5.88

SINGLE-BUTTON LAPEL MIKES

Extra sensitive single-button mikes which give excellent service. Lapel Mike, 98c. Professional Mikes, \$1.76 and \$2.94.

Write for latest pamphlet showing a complete line of MILES NEW EQUIPMENT of public address equipment.

MILES REPRODUCER COMPANY

"Miles Ahead of Others" 244RC West 13rd St., New York, N. Y.

FREE

13th Anniversary Radio Catalog

132 pages containing thousands of the greatest radio and electrical values at real bargain prices. Send for your copy now!

AMERICAN SALES CO.

Wholesale Radio Distributors
RC-44 W. 18th St., N. Y. C.

AUTOCRAT AUTO RADIO 6 TUBE

Quality—Tone—Selectivity & Power

Complete \$29.40—includes set, remote control, suppressor kit, tubes, mounting brackets, dynamic spkr.-antenna. Set only \$10.78. Also 4-5-6-Tube Midsets with latest tubes at low prices. Dealers wanted. Write today.

AUTOCRAT RADIO CO.

3055 N. Hamilton Ave., Chicago, Ill.

Get this New Catalog

Write today for our catalog. It's free. Everything listed at lowest wholesale prices

JOHNSON RADIO MFG. CO.
507 Tarrytown Rd. Pleasantville, N. Y.

SERVICEMEN-DEALERS

Send for our Handbook and Catalog of Radio Replacement Parts

Hard to Get Parts in Stock
Power Packs and Speakers Repaired
NEW LOW PRICES

Grant Radio Laboratories
6521-C South Halsted St., Chicago, Ill.

EXTRA MONEY!

Hundreds of radio Service Men are making extra profit regularly by using Sprayberry Data Sheets—a unique NEW service by one of radio's best known engineers. Sheets tell exactly how to rewire old standard receivers (A. K., Majestic, Spartan, etc.) for modern tubes and circuits—also how to land these profitable jobs. New sheets monthly. Service only \$3.50 a year. Satisfaction guaranteed—a sure tonic for business. Send check or M. O. or write for free details. (Plans for rewiring any set or tube analyzer only \$1).

133 Bryant St., N. W.
F. L. SPRAYBERRY WASHINGTON, D. C.

The Radio-Craft Library Series is handy for reference!

Presented on this page are the new books of the RADIO-CRAFT LIBRARY—the most complete and authentic set of volumes treating individually, important divisions of radio. Each book has been designed to give radio men the opportunity to specialize in one or more of the popular branches of the industry. The material con-

tained in these books will increase your knowledge; you will find them a real help in your work and they will contribute to your money earning capacity. Read these books during your spare time at home.

The authors of these books are well-known to everybody. Each one is an expert radio man; an authority on the

subject—each is thoroughly familiar with the field which he represents.

This is perhaps the first real opportunity that you have ever had to build a radio library of books that are authentic, right-up-to-the-minute and written so that they are easily digested and clearly understood. Mail coupon below for your books.

**TO THE RIGHT
WILL BE FOUND
A SHORT RESUMÉ
OF EACH BOOK**



Book No. 1

RADIO SET ANALYZERS

And How To Use Them

With Full Instructions and Descriptions of Set Analyzers, Tube Checkers, Oscillators, Etc.

By L. VAN DER MEL

This book explains thoroughly the operation of set analyzers, tube checkers, oscillators and other testing equipment. For every radio man this book is extremely helpful. It covers every phase of testing and gives you valuable short cuts; completely illustrated with photographs and diagrams to facilitate the use of modern testers.

Book No. 2

MODERN VACUUM TUBES

And How They Work

With complete Technical Data on All Standard and Many Special Tubes

By ROBERT HERTZBERG

MODERN VACUUM TUBES describes the fundamental electron theory which is the basis of all vacuum tube operation, and goes progressively from the simplest two-element tubes right up to the latest pentodes and thyatrons. It is written in clear, simple language and is devoid of the mathematics which is usually so confusing. Valuable reference charts and characteristic curves of standard and special tubes are to be found, also diagrams of sockets and pin connections.

Book No. 3

THE SUPERHETERODYNE BOOK

All About Superheterodynes

How They Work, How to Build and How to Service Them

By CLYDE FITCH

There is no more fascinating a subject in the large array of radio circuits than the famous superheterodyne circuit. Whether you are a Service Man or experimenter, first-hand knowledge about the construction of superheterodyne receivers is very important. The book on Superheterodynes gives underlying principles of their construction, right from the very first set made.

Book No. 4

MODERN RADIO HOOK-UPS

The Best Radio Circuits

A Complete Compendium of the Most Important Experimental and Custombuilt Receivers

By R. D. WASHBURNE

It is fascinating to the experimenter, or even to the up-to-date Service Man, to take a commercial set and to change it into one using a famous hookup that is not found in any manufactured set. Many excellent circuits have never been commercialized, but limited only to home set builders. Thousands of these popular circuits have been requested from time to time, and in this book we have included over 150 circuits, which include the famous Perdyne, Cash-box, A.C.-D.C. Set and others.

Book No. 5

HOW TO BECOME A RADIO SERVICE MAN

How to Get Started and How to Make Money in Radio Servicing

By LDUIS MARTIN

The ambition of many men in radio today is to become a first-grade Service Man. It is not as difficult as one might believe, but it cannot be done in a few short months. Following very carefully the advice of Mr. Martin, who has dealt with the problems of thousands of Service Men, this book deals very carefully with the essential stages in the preparation for qualifying as a Service Man.

Book No. 6

BRINGING ELECTRIC SETS UP TO DATE

With Pentodes, Multi-Mus, Dynamic Speakers—Complete Information How to Modernize A. C., D. C. and Battery Operated Receivers

By CLIFFORD E. DENTON

In this country there are over ten million electrically operated receivers that could be modernized—by placing in them new type tubes, new speaker equipment and other modern improvements. This business of improving old sets can go to the experimenters and Service Men if they will quickly jump into action.

Read in this book by Mr. Denton, how easily you can modernize any obsolete set, and with little additional costs.

Book No. 7

RADIO KINKS AND WRINKLES

For Service Men and Experimenters

A Complete Compendium on the Latest Radio Short-Cuts and Money-Savers

By C. W. PALMER

It often becomes necessary for experimenters and Service Men to call upon their memory for some short cut or radio wrinkle that will solve a problem quickly. In business, "short cuts" mean time and money saved, and to the Service Man "time saved" means money earned.

This book is a compilation of important radio kinks and wrinkles and discusses only such items as are constantly used today.

Book No. 8

RADIO QUESTIONS AND ANSWERS

A Selection of the Most Important of 5,000 Questions Submitted by Radio Men During the Course of One Year

By R. D. WASHBURNE

There have been collected a wide variety of questions which have come into our editorial offices during the past two years, and only those whose answers would benefit the majority of men engaged in radio have been incorporated in this amazing question and answer book. A tremendously long list of topics is treated.

Book No. 9

AUTOMOBILE RADIO AND SERVICING

A Complete Treatise on the Subject Covering All Phases from Installing to Servicing and Maintenance

By LOUIS MARTIN

Automobile radios are up and coming, and someone has to service them properly. It therefore behooves you to read this immensely important new book on the art of Automobile Radio. The book is concise, and full of illustrations, photographs, diagrams and hookups.

A few of the really interesting chapters: Introduction; Automobile Radio Installations; Complete Descriptions of Commercial Automotive Receivers; Servicing Automotive Receivers; The Ignition System; General Service Considerations; Effects of Temperature on Power Supply; Conclusion.

Book No. 10

HOME RECORDING AND ALL ABOUT IT

A Complete Treatise on Instantaneous Recordings, Microphones, Recorders, Amplifiers, Commercial Machines, Servicing, etc.

By GEORGE J. SALIBA

If there is one subject that is fascinating to every radio man, it is that of Home Recording. Of course, this volume is not all on "Home" recording, but the information contained therein is important to commercial radio men, studio operators, engineers and others interested in this phase of radio.

The art of recording and reproducing broadcast selections is becoming more important every day to radio men, experimenters and Service Men. Equipping dance halls, auditoriums, churches, restaurants and homes with public address systems and amplifiers brings many extra dollars and often an excellent income.

BIG DISCOUNT OFFERED

In order to make it possible for everyone to buy these books, the fifty (50) cent price has been made uniform for all volumes. You can buy these books separately, but you should take advantage of our special offer:

When Five (5) Books or More Are Ordered Deduct 20% from Your Remittance

Simply fill in the coupon below, and mail it to us together with your remittance. Checks, stamps or money orders accepted.

ALL BOOKS UNIFORM

The books in the new RADIO-CRAFT LIBRARY are all strictly up-to-date, and written by men who know their subjects. The volumes are all uniform size, 6 1/2 inches, and contain on an average of 50 to 100 illustrations. Each book is printed on fine book paper, and no expense has been spared to make it an outstanding value, for its editorial contents as well as from the mechanical standpoint.

Clip Coupon and Mail Today!

GERNSBACK PUBLICATIONS, INC., 96-98 Park Place, New York, N. Y.

I have circled below the numbers of books in the RADIO-CRAFT LIBRARY, which you are to send me, and have deducted 20% for ordering five (5) books or more. I have included my remittance in full, at the price of 30c each, when less than five books are ordered.

The amount of my remittance is..... (Stamps, checks or money orders accepted.)
Circle numbers wanted: 1 2 3 4 5 6 7 8 9 10

Also, please send me POINT-TO-POINT RESISTANCE MEASUREMENTS, book number 11 ()

Name..... Address.....

City..... State..... RC-4-33

POINT-TO-POINT RESISTANCE MEASUREMENTS, the latest book in the Series, will be published by March 10th.

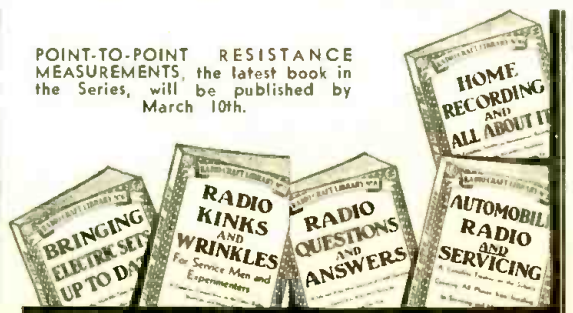

ROUND THE WORLD RECEPTION!

WITH POWERTONE SHORT-WAVE RECEIVERS

Battery Operated Receiver

Amazing results on this set have convinced us that we have reached the utmost in the reception of short waves with a battery operated receiver. The beautiful vernier dial gives the set a strictly modernistic finish and at the same time greatly improves the ease of tuning. With the set of four plug-in coils furnished with the above receiver, the wave lengths from 14-200 meters are covered.

\$9⁹⁵
less tubes

Uses the new battery tubes (232 and 233). Special Hammarlund Condenser. Unusually fine reception. Fine modernistic finished cabinet. Covers complete short-wave range. Extremely sensitive.

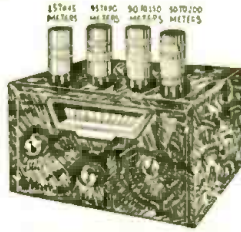

YES, stronger than ever, so do we voice our and countless other opinions on this remarkable shortwave battery operated receiver. Faster than ever in sales volume, for the public has caught up with us in voicing their enthusiasm on results with this receiver. Never before has reception such as this been available on any two or three tube battery operated shortwave set.

Regular long wave coil (200 to 550 meters). . . . 95c. Can be used for both Battery Operated and A.C.

A. C. Model Receiver

Unsurpassable construction—New and Improved HAMMARLUND tuning condenser; special oversized electrostatically-shielded power transformer; four new improved INSOLANTITE plug-in coils covering the wave length from 15 to 200 meters; complete shielding which reduces dielectric losses to a minimum and assures maximum and uniform efficiency under all conditions; Lynch color-coded R.M.A. resistors used throughout entire construction. Enclosed in a solidly constructed beautifully finished metal cabinet with hinged top to facilitate ease of interchanging wave-length coils. Modernistic Full-Vision Vernier.

\$15⁹⁵
less tubes

ONE OF OUR OUTSTANDING VALUES

Stromberg-Carlson Magnetic Pick-up



Here is a phonograph pick-up that will meet the requirements of the most discriminating. Made by a firm that is well known for high quality and well designed instruments. The tone arm is balanced for light needle pressure. A well designed input transformer, 21 foot cord, pickup plug and volume control complete the assembly. Thousands in quality unsurpassed. This use in the best installations. This pick-up can be used for home recording due to its low impedance. (200 ohms).

\$7⁵⁰

There is nothing finer than a Stromberg-Carlson.

Kellogg Hand Mike



Used with Victor R. E.-57 and R.C.A. 86 Home Recording Combinations

A single-button Microphone fine for home recording and amateur broadcasting. 100 ohm button. Operates from a 1 1/2 v. dry cell and draws 10 mils. Gun metal finish, equipped with 5 ft. cord.

Your Price **\$1⁴⁵**

STROMBERG-CARLSON PHONOGRAPH PICK-UP

A handsome and serviceable combination for records with minimum effort and maximum efficiency. Mounted in a beautifully walnut finished "treasure chest" cabinet. The STROMBERG-CARLSON pick-up, one of the finest available, is equipped with volume control, and excellent reproduction of extreme volume with the minimum needle scratch is made possible by the carefully engineered "phono Prime Green Giant" will not set up any disturbing noises, and will not hum.



\$15⁹⁵

R. C. A. Magnetic Speaker Chassis

This chassis is the identical one used in the R. C. A. Model 100-A and 100B Speakers. WHICH LIST PRICE AS HIGH AS \$35.00. Note built-in OUTPUT TRANSFORMER—permits use of 450 volts, without distortion, retuning or blasting. GENUINE OVER-SIZED MAGNETS. The thick armature is ACCURATELY CENTERED. The STURDY METAL FRAME IS LINED WITH A SPECIAL SELF-BAFFLING FABRIC, greatly improving acoustic properties of this sensational speaker! Note the Corrugated Surface of the Cone, an Exclusive Feature—Enhances Perfect Tone Reproduction Qualities. Considerably more. Compactly made. 8 inches outside diameter, 4 1/2 inches deep over all.

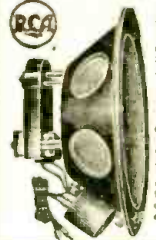

Your Price **\$2⁹⁵**

POWERTONE Single 245 Amplifier

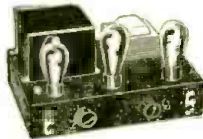

In the design and construction of this amplifier, liberal safety factors have been allowed. The Powertone 245 Amplifier has a power output of approximately 3 watts, which when used with one or two dynamic speakers is quite the ideal thing for auditorium or home use, intercommunication in factories or large offices. An exclusive method is provided for the use of a high impedance phonograph pick-up or radio tuner. A microphone can easily be connected when used with a suitable coupling unit. The power consumption of the Powertone single 245 Amplifier is around 40 watts. All material used in the construction of this amplifier has been thoroughly tested in the most competent manner known to the Radio Science. Cat. No. 702—Model 45 (Uses 1-224, 1-245, 1-280 Tubes). Our Price

\$10⁹⁵

NEW IMPROVED TYPE FARRAND INDUCTOR DYNAMICS

Used on A.C., D.C. and Battery Sets with Equal Results.

9" Model.....\$4.95
12" Model **\$5.95**



JANNETTE MOTOR

To supply 110 volt 60 cycle a.c. in areas where the supply is 110-115 volt d.c. Will operate continuously over long periods without heating. Floor Models.

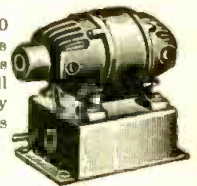

180 Watt **\$18⁵⁰**

500 Watt **\$27⁵⁰**

Bosch Speaker Cabinet

12 1/2" high, 12" base width. A beautiful walnut cabinet that is attractively finished and hand-rubbed to a soft, satiny sheen. Will lend itself to any setting. Will take any chassis up to 10 1/2" in diameter.



Price **\$1⁹⁵**

CROSLY POWER PACK

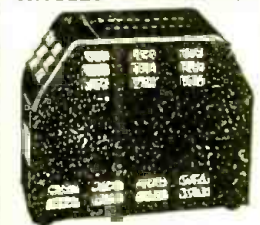

Model 104-R. A complete power pack which supplies filament and plate current. 5 volt filament, 280 tube, 1 1/2 volt filament, 2 1/2 volt filament, 5 volt filament and 180 volts tapped at B minus, B plus 180 and C plus 180. Both models consist of 2 chokes, 1-mercuron condenser, voltage divider, and many other items which if were to be taken out of the packs would pay for the pack many times.

Model 104-R **\$4⁹⁵**
Model 104 each

PRIME A. C. MOTOR



A sturdy powerful compact heavy duty motor of the self-starting induction type. Will not set up disturbing noises in any receiver. Equipped with large bearing surfaces to provide adequate support and to insure long life. Quick starting, full speed is attained instantly. Comes ready to mount with turntable, mounting plate, on-off switch and speed control.

Your Price **\$5⁵⁰**

FARRAND MAGNETIC CHASSIS

9" Diameter. The Farrand chassis is one of the finest magnetic chassis available today. It has a balanced armature which enables it to handle a large amount of volume without distorting or rattling, yet it will be exceedingly sensitive to weak signals.

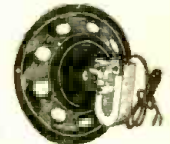

Cat. No. 5301. **\$1⁷⁵**
Our Price

All offers are F. O. B. New York, and subject to prior sale. Terms: A deposit of 20% is required with every order. Balance may be paid on delivery. Or, deduct 2% if full amount is sent with order.

GRENPARK CO., Dept. RC 245 GREENWICH STREET, NEW YORK, N. Y.

POWERTONE

SHORT WAVE

AC AND D.C. RECEIVERS



A CHALLENGE WHAT MORE CAN ANY S. W. SET OFFER?

Now you can buy a SHORT WAVE RECEIVER that you can have the utmost confidence in, for it contains everything you desire—FINEST QUALITY PARTS—SUPER CONSTRUCTION—and most importantly, WONDERFUL RECEPTION. A tremendous purchase of AC and DC Sets permits us to sell them at such a ridiculously low price that now every radio enthusiast can afford to own one. New and improved HAMMARLUND tuning condensers. Special oversized electrostatically-shielded power transformers. Four new, improved POWERTEST plug-in coils covering wave lengths from 15 to 200 meters. Complete shielding which reduces di-electric losses to a minimum and uniform efficiency under all conditions. LYNCM color-coded R. M. A. resistors used throughout entire construction.

We Take Extreme Pride in the Construction of These Sets—

We have tried to perfect a short wave receiver so that it would give complete satisfaction, as well as being within the means of everyone desiring a set. We believe that our endeavors have been fulfilled. You are assured of the finest receivers at the lowest prices. Our Battery-Operated Receivers are constructed similarly to the A. C. sets. They also are made with the new, improved HAMMARLUND tuning condensers, and only LYNCM color-coded resistors used throughout the entire construction. The FULL-VISION, SLOW MOTION TUNING DIAL IS AN EXCLUSIVE POWERTONE FEATURE ON BOTH AC AND DC RECEIVERS. Prices include four new, improved type POWERTEST plug-in coils covering wave lengths from 15 to 200 meters.



The hinged cover as illustrated, facilitates removal of tubes and coils. An exclusive Powertone feature.

- ### A. C. RECEIVERS
- 3-Tube Wired **\$14.95**
Kit of Parts \$12.75
RCA Licensed Tubes (58, 57, 80) . . . \$2.35
 - 4-Tube Wired **\$19.75**
Kit of Parts \$16.95
RCA Licensed Tubes (58, 56, 47, 80) \$2.95
 - 5-Tube Wired **\$24.95**
RCA Licensed Tubes (2-58, 56, 59, 80) \$3.95

- ### BATTERY OPERATED
- 2-Tube Wired **\$9.95**
Kit of Parts . \$7.95
RCA Licensed Tubes (232, 233) . . \$1.50
Complete set of batteries . . . \$2.75
 - 3-Tube Wired **\$12.95**
Kit of Parts \$10.75
RCA Licensed Tubes (34, 2-30) . . \$2.15
Complete set of batteries . . . \$2.75

Beautifully Finished Modernistic Cabinet

Its graceful lines will lend itself to any room setting. Sturdily built.

POWERTONE T. R. F. TUNER

Plug into any amplifier and make a receiver with this splendidly constructed Tuner. Made of the finest parts including HAMMARLUND tuning condensers. Uses high gain shielded H. F. coils. Tuners available with 3 or 4 stage condensers.

- 3-gang (uses 2-58 & 56 Tubes) **\$6.95**
Kit Form \$5.45
- 4-gang (uses 3-58 & 56 Tubes) **\$8.95**
Kit Form \$7.45

BALDWIN HEAD PHONES

Remarkably sensitive and rugged. They will enable you to bring in long distant stations with clearer and louder signals. The two units are perfectly matched for quality and maximum volume.

Price \$3.75

SANGAMO P. P. Input, Output, and Audio Transformers

The input transformer has a high primary impedance, insuring maximum amplification at low frequencies. The secondary is accurately divided to secure practically identical frequency characteristics. Output transformer has an impedance that matches the voice coil impedance of any standard dynamic speaker.

Each . . . \$1.25
Per Pair \$2.45

AUDIO TRANSFORMER
The curve of the audio transformer is as near perfect as possible. Well insulated and shielded. 3 to 1 ratio.

Price \$1.45

POWERTONE Microphone Input Stage

Made for single or double button microphones. Will match any two button mike to the grid and filament of any tube or to any phonograph jack of an amplifier. Uses one standard No. 6 Dry Cell. The secondary of the transformer is shunted by a volume control. A battery switch is used for on and off control.

- Double Button . **\$3.95**
- Single Button . **\$3.50**

R. M. A. Color-Coded Resistance Kit. 1 watt

36 most commonly used. Odd-sized values obtainable by connecting two or more in series or parallel.

100	1000	10000	1 meg.
150	1500	15000	2 meg.
200	2000	20000	3 meg.
250	2500	25000	5 meg.
350	3000	50000	7 meg.
450	5000	75000	10 meg.
500			
600			
750			
850			
900			
1000			
1500	10000	100000	1 meg.
2000	15000	150000	2 meg.
2500	20000	200000	3 meg.
3000	25000	250000	5 meg.
4000	30000	500000	7 meg.
5000	50000	750000	10 meg.

Price, \$3.45
FREE 0-10,000 ohm resistance meter with each purchase of this kit!

POWER-TONE Floor Microphone Stand

Specially designed for rigidity with heavy base for firm solid support. Beautifully silver-finished. Extends from 45" to 61". A large size screw securely holds extension in place. Has best suspension hooks for easy insertion of mikes.

Weight 12 lbs.
Price \$3.95

POWERTONE MIDGET DYNAMIC SPEAKERS

Manufactured by one of the largest speaker manufacturers in the country. Compact in size, and realistic in tone performance. They are equipped with transformers to match any type of power tube. Field resistance can be had in either 1800 ohms tapped at 300 or 2500 ohms. Overall size 6".

Price \$1.95

UNIVERSAL Midget Power Transformer

Can be used as a replacement for midget sets using a 45 or 47 power tube. Primary 110-115 volts. High voltage 700 Volts C. T. (350-350 volts). 5 volt winding at 2 amps. for 70 type rectifier. 2 1/2 volt winding at 8 1/2 amps.

Price 95c

FLETCHEIM 0-500 D. C. Meter

Uses only 5 mls. Current resistance 200 ohms per volt. Highly nickle finished. Flexible cords.

Price \$1.35

POWER-TONE Modernistic Stand Floor Stand

Beautiful handcut stand adjustable from 22" to 32". Heavy chromium in an unusual modernistic design. 3/4" ring with four best suspension hooks for easy insertion of mikes. Strong screw holds extension firmly.

Weight 11 lbs.
Price \$7.95

TRY-MO RADIO CO. INC. 85 CORTLANDT ST. DEPT C3 NEW YORK, N.Y.

Compare Our Prices and See For Yourself! WE LEAD THE FIELD IN VALUE AND QUALITY

100B Chassis in Bosch Cabinet



The famous R.C.A. chassis mounted into a beautiful, satiny finish Bosch Cabinet. It reproduces original renditions with the utmost faithfulness and clarity. Will lend itself to any setting, and may be used with any type of receiver.

\$4.90

Price.....

ONE of our OUTSTANDING VALUES

Stromberg-Carlson

MAGNETIC PICK-UP OUTFIT



The original Stromberg-Carlson Pick-Up Outfit at this rock-bottom price. Our price includes Stromberg-Carlson Input Transformer, Stromberg-Carlson Magnetic Pick-Up with built-in volume control, phonograph plug and 20 ft. special insulated extension cord. **OUR OUTFIT IS COMPLETE—NOTHING ELSE TO BUY!** We carry these pick-ups in stock, thus assuring **IMMEDIATE DELIVERY.**

\$7.50

NOTE! We will allow you \$2.00 for your old pick-up, thus making your price only \$5.50 for an outfit listed at \$30.00.

100B Magnetic SPEAKER



A speaker flawless in tone and which has volume not ordinarily found in magnetic reproducers. Encased in a modernistic cabinet. Speaker is dust-proof, thus assuring permanent and efficient performance.

Price..... **\$4.95**

FARRAND Permanent Magnet NEW TYPE SPEAKER CHASSIS

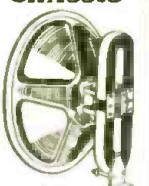

A speaker second to none for tonal qualities. One of the most recent types developed. Uses two powerful magnets to supply the fixed magnetic field. Matched for power tubes. State types when ordering.

Price 9" **\$4.95**
12" **5.95**

JENSEN JR. AUDITORIUM DYNAMIC



Widely used as a public address speaker. Uses a 280 rectifier system in conjunction with an 8 mfd. electrolytic condenser, eliminating any hum found in the ordinary A. C. Dynamic speaker. Overall size 12" high, 11 1/2" wide and 7 1/2" deep.

\$8.95

complete with tube

POWERTONE "PAL" A. C. Dynamic Speaker



An A. C. Speaker measuring only 10 1/2" long, 6" wide, 7" high.

There is no need to purchase an additional receiver for those who wish to install one in another room. This speaker can be used as an addition to any radio receiver. A full sized 6" dynamic speaker in a beautifully designed cabinet. The speaker has a volume control and an off and on switch.

Your choice of the following speakers in the illustrated cabinet:

JENSEN	\$6.50
ROLA	6.50
WRIGHT de COSTER	6.50
POWERTONE	6.50
B. B. L. (Magnetic)	4.95

R. C. A. Single Button Carbon Microphone NOT A TOY!



Its fine response curve makes it suitable for home recording and amateur broadcast. Inc. 100 ohms, operate from a 1 1/2 dry cell and draw 10 mls. Equipped with 5 ft. cord.

\$1.45

DeJUR AMSCO VARIABLE CONDENSER

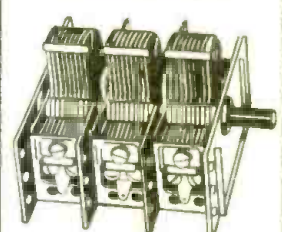

A small and light .00035 three-gang variable condenser. The tuning curves are designed to meet present day requirements. Accurate to a new practical degree of perfection. Each section is provided with individual compensator. Perfect bearings.

\$1.25

.00014 2 gang condenser 69c

STROMBERG-CARLSON Portable Electric Phonograph



Equipped with PRIME MOTOR. Contained in an unusually attractive leatherette carrying case. 16 1/4" long, 13" wide, 7 1/4" high. Weighs about 10 lbs. For 110 volts, 60 cycles A. C.

For 78 RPM..... **\$14.75**
For 78 and 33 1/2 RPM..... **18.75**

Modulated Oscillator



Provides 100% modulated signal at all frequencies in the broadcast band and at all those frequencies commercially employed in the intermediate amplifiers of superheterodynes. The tenth harmonic is used for broadcast receiver testing and readings are obtained directly from a calibrated scale reading from 55 to 155 k. c. by simply annexing a cipher mentally to the dial reading. The calibration is accurate within 3% at all settings and to 2% over the greater portion of the range. Using a single 50 tube the strength of oscillation is sufficient to produce a signal by radiation without special coupling and arrangements. The immediate frequencies calibrated are 115, 130, 172.5, 175, 177.5, 200, 400 and 450 k. c.—all commercially employed frequencies.

\$6.95

A. C. Model.....
R. C. A. licensed Tube..... .76
Battery Operated with 230 tube using 3 volt and 22.5 volt batteries (price, less tube and batteries)..... 6.53
R. C. A. Licensed Tube

NEW BEEDE METERS D'Arsonval Movement Lowest Prices



Beede moving coil instruments are available at prices which are amazingly low for the type of instrument. Unusual ruggedness, high accuracy, and freedom from dust and foreign matter. Perfectly balanced in all positions, and the moving system is exceptionally well-damped.

Accuracy is guaranteed within 2%.

Model 701 Panel Instruments—Flush Type

D. C. Milliammeters—Single Range

Range	Price	Range	Price
0-1.....	\$4.12	0-30.....	\$3.25
0-1.5.....	4.12	0-50.....	3.25
0-2.....	4.12	0-100.....	3.25
0-3.....	4.12	0-150.....	3.25
0-5.....	3.25	0-200.....	3.25
0-10.....	3.25	0-250.....	3.25
0-15.....	3.25	0-300.....	3.25
0-20.....	3.25	0-500.....	3.25
0-25.....	3.25	0-800.....	3.25
		0-1000.....	3.25

D.C. Voltmeters—Single Range

Resistance approximately 125 ohms per volt

Range	Price	Range	Price
0-1.....	\$3.25	0-50.....	\$3.25
0-2.....	3.25	0-100.....	3.25
0-3.....	3.25	0-150.....	3.25
0-5.....	3.25	0-200.....	4.12
0-8.....	3.25	0-250.....	4.12
0-15.....	3.25	0-300.....	4.80
0-20.....	3.25	0-500.....	5.50
0-25.....	3.25	0-1000.....	8.60

DEPENDABLE Tube Checker



The greatest tube tester value ever offered. Tests all the new tubes as well as the old ones without adapters. Equipped with 4, 5, 6 and 7 prong sockets. Encased in handsome leatherette case with deluxe handle and removable hinge cover. Operates from AC socket. Size 11 x 9 x 5 inches.

Price..... **\$13.50**

SEND FOR OUR NEW CATALOG.
We have everything pertaining to radio at lowest prices. Our immense stock insures PROMPT DELIVERY. Our immense 20% deposit must accompany all C.O.D. orders.

TRY-MO RADIO CO. INC. 85 CORTLANDT ST. DEPT C3 NEW YORK, N.Y.

APRIL SPECIALS!!

EVERY month we list on this page certain STAR items, which are NOT LISTED IN OUR CATALOG. These are all specials of which the quantities on hand are not sufficient to catalog them. Once sold out, no more can be had. First come, first served. ORDER NOW, TODAY.

STOP SHOPPING. The lowest prices are right on this page. No one undersells us. We meet any price on ANY NEW Merchandise. Order direct from this page and save money. 100% satisfaction on every transaction. Take advantage of these special offers. ORDER NOW, TODAY.

Only
\$10.85

Greatest Buy In America!

Only
\$10.85

*"PEERLESS" 8-TUBE SCREEN-GRID T.R.F. RADIO RECEIVER

Complete with Full Dynamic Speaker

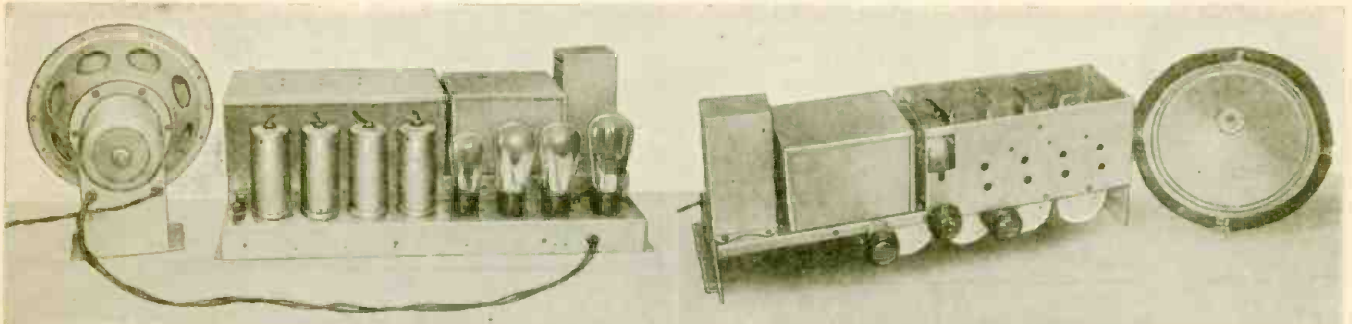

Back View

Front View

Limited Supply—Only as Long as They Last—Order Today

IF EVER there were a greater value than this offered before, we have yet to see it. The selectivity and sensitivity of this 8-tube receiver due to its four tuned stages are just as sharp as those of an expensive 11-tube Superheterodyne receiver. The construction of this receiver is best described as "standard." Its circuit is none other than the "good old standby" TRF type which is the most reliable and the most foolproof ever designed. It incorporates three stages of tuned R.F. amplification using type "24 Screen-grid tubes; the power detector is a "24; a single stage of AF voltage amplification utilizing the type "27 tube, feeds a pair of '45's in push pull, the full wave rectifier is an '80. All provisions are made for supplying field power for the 9 inch TCA (Transformer Corporation of America) full dynamic speaker. Both cone and spider of this excellent reproducer are made of Birtex to improve the high note response (brilliance) without impairing the low note production. Tuning is extremely simple, the tuned circuits being controlled by a single central knob; a vernier drum-type illuminated tuning dial is employed. The second knob controls the on-off switch and the third, the one on the right, volume control. Coils, tuning-condenser-gang, filter condenser bank, output choke and by-pass condenser bank are all individually shielded. The chassis itself is made of non-magnetic aluminum. The use of four tuned circuits, employing screen-grid tubes and high gain R.F. transformers, together with careful wiring, and by-passing, result in high sen-

sitivity. Many of our satisfied customers inform us that a good variety of distant stations come in like locals. Tone quality, too, is extraordinarily fine. Despite the maze of new tubes recently thrown upon the market, it is generally conceded that for average home use push pull '45's supply adequate power with the least distortion. Why build a set when a complete receiver, wired and ready to use, and complete with speaker, can be bought at this phenomenally low price? Here is an excellent opportunity for wide-awake service men to "clean up." There are little more than 100 of these receivers left and at this low price, they are bound to give out in very short order. Experimenters will find in this chassis the laboratory "monitor" they have been waiting to buy "when things get cheaper." Remember that the supply is limited. Hence, "first come, first served." The moral is don't delay, order today. Overall size 21" x 8" x 8 3/4" (set only). Shlb. wt. 45 lbs.

List Price \$75.00

NO. SP-2000 Peerless 8-Tube TRF Receiver

YOUR PRICE with speaker but less tubes

\$10.85

LIMITED SUPPLY—ORDER TODAY—TOMORROW MAY BE TOO LATE

Official Doerle 2-Tube 12,500 Mile Short Wave Receiver

THERE have never been produced short-wave receivers which have taken the whole country by storm as much as the now famous DOERLE Receivers. Mr. Doerle described this receiver, the now famous TWO-TUBE 12,500 MILE RECEIVER in the December-January issue of SHORT WAVE CRAFT. You have seen the many letters published in SHORT WAVE CRAFT lauding this receiver to the skies, and for a good reason. It is a low-priced receiver, yet, pulls in short-wave stations from all over the world, REGULARLY, in practically any location, not only in this country, but anywhere. Thousands of experimenters have built their own, and have obtained miraculous results, no hundreds of glowing testimonial letters from radio fans testify.

In the course of the year, we have received many requests for this receiver and have sold a great many parts for it, but not until recently have we concluded our tests which now places us in a position to supply it in either kit form or completely wired and assembled, ready to use.

It took a lot of labor, and much ingenuity to collect the correct parts to make sure that this receiver would work under all circumstances. This means that all the usual "bugs" have been ironed out by us in such a way that you may order every receiver with full confidence, that in practically every location, anywhere, "it will do its stuff."

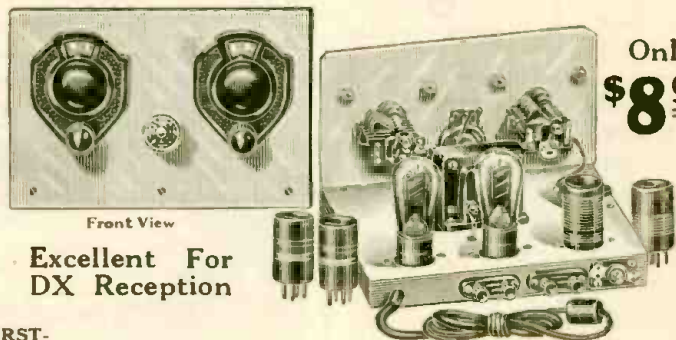

Front View

Rear View

Only
\$8.90

Excellent For
DX Reception

FREE RADIO AND SHORT WAVE TREATISE



The new Winter, 1933 edition of our Radio and Short-Wave Treatise, No. 28 has just come off the Press—104 solid pages of useful information, radio items, diagrams and illustrations. Positively the greatest book in print—NOT JUST ANOTHER CATALOG. Contains a large editorial section with valuable information not found anywhere else. Special consideration has been given to the radio beginner in this issue. Among the new technical information listed are the following:

HERE IS A PARTIAL LIST OF CONTENTS
Fundamental Principles of Radio—Ohm's Law—Discussion of New Tubes—Constructing a "Triple-Twin" Amplifier—All about Superheterodynes—Eliminating Man-Made Static—Constructing a Two-Tube Short-Wave "Globe-Trotter" Receiver—\$3.00 Prize Suggestions—Radio Kinks, etc., etc.

WRITE TODAY. Enclose 4 cents for postage. Treatise sent by return mail.

ONLY FIRST-CLASS PARTS USED

It may be possible to buy the parts of this completed set as a lower price. We admit this at once. But if you will look over our parts list, you will find that only first class material is used. We have done away with all losses. There is no "hand capacity" in this set. ONLY THE BEST CONDENSERS—A N D THAT MEANS HAMMARLUND ARE USED. The set could be produced for a considerable less amount if we used cheaper condensers. We have refrained from doing so because we wanted a first-class product. And this goes for everything else in the set. They are low in price, yet the quality is excellent considering the low price. Thus, for instance, we are using Kurta-Kasch dials because we found them excellent for their

purpose, and as everyone knows, they are really first class verniers. The sub chassis are of non-magnetic, satin-finished aluminum, completely drilled. Panels are polished aluminum, on which the condensers and other parts are mounted. These panels do away with hand capacity. The plug-in coils are of Bakelite, wound with enamel wire for low losses. In short, despite the exceedingly low price of these sets, we give you quality. Bakelite sockets only are used. Even the aerial condensers are of the Micromold Equalizing type. We have even included pin-tip jacks, rheostats with switch and binding post strips of Bakelite to keep down losses. In short, you will be pleased not only with the business-like appearance, but with the performance as well.

Only by making these sets in quantities can we afford to sell them at the extremely low prices quoted.

- This receiver is exactly as illustrated in our photograph. Size of aluminum panel is 9 1/2 x 11 1/2 inches. List of material used: 2 Hammarlund .00014 Condensers; 1 Carter 20 ohm Rheostat and Switch; 1 Peerless Audio Transformer; 2 Kurta-Kasch Vernier Dials; 3 Bakelite Low Loss Sockets; 1 Micromold Equalizer Antenna Condenser; 1-.0001 Aerovox Fixed Condenser; 1-5 megohm Carbon-dum Grid Leak; 2 Telephone Pin Jacks; 1 Aluminum Panel; 1 Vernier Baseboard; 1 Bakelite Rheostat Knob; 1 Bakelite Binding Post Strip; 1 set of 4 Bakelite Short Wave Plug-in Coils; Instructions for Operation; 1 Set of Hardware, Wire, etc. Complete shipping weight 5 lbs. YOUR PRICE **\$8.90**
- No. 2141. TWO TUBE 12,500 MILE DOERLE SHORT WAVE RECEIVER KIT, with all parts as specified above, but not wired, with blueprint connections and instructions for operation. Complete shipping weight 5 lbs. YOUR PRICE **\$7.70**
- No. 2142. COMPLETE ACCESSORIES, including the following: 2 six months guaranteed Neontron type No. 230 tubes; one set of No. 1678 Brandes Matched Headphones; 2 No. 6 standard dry cells; 2 standard 45-volt "B" batteries. Complete shipping weight 23 lbs. YOUR PRICE **\$5.40**

WE ARE A WHOLESALE HOUSE AND CANNOT ACCEPT ORDERS FOR LESS THAN \$3.00. In C.O.D. shipment is desired, please remit 20% remittance, which must accompany all orders. If full cash accompanies order, deduct 2% discount. Send money order—certified check—U. S. stamps.

Radio Trading Co.
102 Park Place
New York, N. Y.

ORDER FROM THIS PAGE. You will find special prices from time to time in this magazine. Get our big FREE catalog for the greatest Radio Bargains. Should you wish goods shipped by parcel post, be sure to include sufficient extra remittance for same. Any excess will be refunded.

An Interference Neutralizer

Dr. F. Noack*

In these days of fully-shielded radio receivers, incorporating modern designs of tubes, the points of interference pick-up can usually be classified as (a), antenna pick-up, and, (b), power line pick-up. The degree of interference which may be picked up by the antenna is purely a matter of local interference conditions, and positioning of the antenna and its lead-in with respect to the source, or sources, of interference.

If the generated interference does not cover too wide an area, it is possible to place the antenna at a point outside of the affected area, and run a long lead-in, fully shielded, from the antenna to the radio set; in some cases it may be desirable to boost the intensity of the incoming radio signal by means of an aperiodic, remote-controlled R.F. amplifier; a further refinement is the use of an R.F. transmission line in lieu of the more common, high-loss shielded lead-in.

Interference picked up by the power line may originate at very remote points and yet become evident in the receiver. The use of line filters incorporating inductance, resistance and capacity usually take care of all such parasitic oscillations. A good ground connection is a big help in securing complete filtration.

However, a much less expensive scheme, illustrated in Fig. A and shown by diagram in Fig. 1, may often be used with the greatest success. In this method a "neutralizing" effect is secured which is reminiscent of the "neutrodyne" circuits of a past heyday. The principle involved is clearly shown in the schematic circuit.

In this illustration, Fig. 1, a condenser system consisting of units C1, C2 and C3 is connected to pick off a portion of the interference existing on the power lines, and to feed it into the antenna circuit of the receiver, but 180 degrees out of phase with the same interference being picked up by the antenna system: thus, the two out-of-phase currents buck out, theoretically. The extent to which theory is approached in practice is a matter dependent upon the particular type of interference; its intensity, and the phase relation of its pick-up in the antenna circuit with respect to the phase relation of the power-line pick-up, and the transmission characteristics of these two. In general, adjustment of condenser C1 will result in securing at least a semi-null point which shows an appreciable improvement in the signal-static ratio.

The following parts are required to construct this "interference neutralizer": One .0005 mf. variable condenser, C1; one .005-mf. fixed condenser, C2; one 0.1-mf. fixed condenser, C3; one line-plug, PLUG; one length of shielding, SHIELD; one Blan shield-can, 5 x 5 x 5 ins. high, SHIELD-CAN; one binding post, GND.; one K-K knob (for condenser C1). It is essential that condensers C2 and C3 be of high quality and of at least 300 V. (operating) rating, as they must insulate the power line from the radio receiver so that the line potential and any surges will not blow up the works."

The variable condenser, C1, as well as fixed condenser C2 must be insulated from the shield-can, as indicated in the schematic circuit; condenser C1 appears in Fig. A, but condenser C2 was not within the range of the camera.

The binding post marked GND. fastens directly to the tight-fitting, aluminum shield-can. Connect to the shield-can post the ground wire which formerly connected to the ground binding post on the radio set; the ground circuit of the set is completed by means of the high-capacity ground coupling condenser C3. To the antenna post of the set is connected not only the lead-in from the antenna, but also one lead from the rotor of the variable condenser, the other side of the condenser connects to the line-plug.

This plug is connected only on one side and therefore it is necessary to reverse the position of the plug in the service-outlet socket until best interference-balancing is obtained when C3 is adjusted. It will be noted that the power line is indicated as being run in conduit; whether this casing is conduit or BX is a matter of individual preference although, in any event, some such shielding should be used around these strong-field leads where they are located within the possible pick-up field of the set.

One of the two leads from the shield-can is shielded; whether the other one is to be shielded will depend upon whether this wire must be run any considerable distance, and whether it may necessarily parallel wires in the antenna circuit.

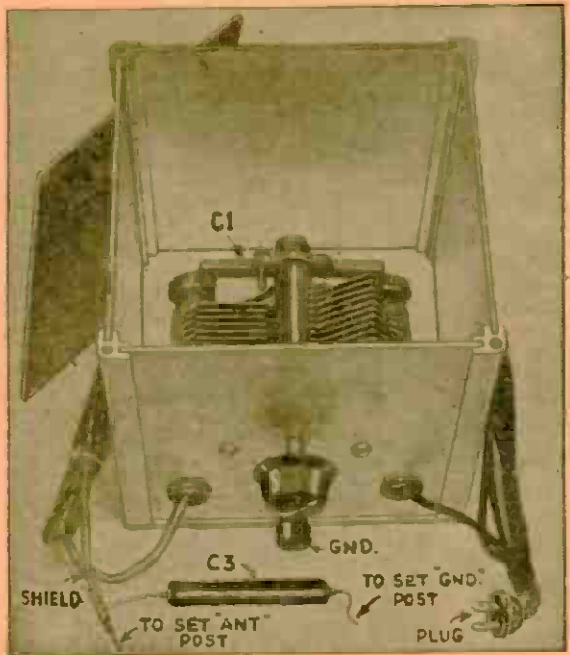

Fig. A

Interior view of the interference neutralizer. Adjustment of the variable condenser does the trick.

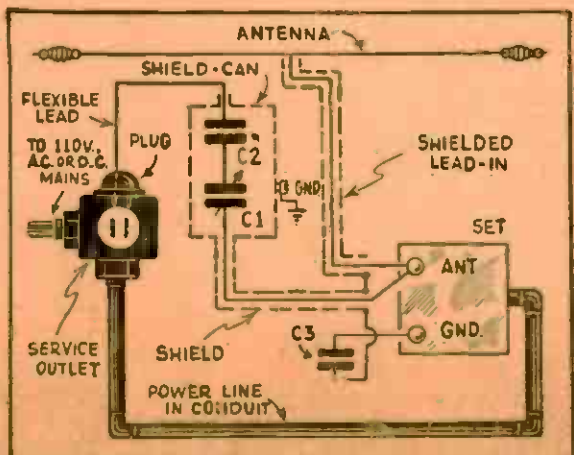

Fig. 1

Schematic circuit of the interference neutralizer. Simplicity itself.

*Berlin, Germany.

ELECTRIC CURRENT—

In Wires, Gases and Vacuum

Dr. A. W. Hull*

I shall not try to tell what electricity is—I confess I don't know—but rather to describe how it behaves. *Behavior* is all that the scientist is able to observe. If, for brevity, he says "Electricity is," you may be sure that he means "behaves"; exactly as you, when you say your friend is honest, means only that he behaves honestly, as far as you have observed, and not that you have analyzed and understand his moral nature.

Electric current behaves like—hence, for brevity, we shall say is—a stream of tiny particles, called electrons. An electric current in a wire is very much like a current of water in a pipe. The analogy is still closer if the pipe is filled with sand, the grains of sand corresponding to the atoms of the wire. Between these atoms the electrons wend their tortuous way, as water diffuses through sand. Let us look at the picture more closely. The wire is copper. It is full of tightly packed copper atoms, each a nucleus surrounded by 29 electrons. One of these 29 is a vagrant so loosely held by its nucleus that it can wander about freely between the other atoms. *It is these free electrons, one from each atom, which drift through the wire and constitute the "electric current."*

We are accustomed to think of electricity as "lightning fast." But electrons may also move slowly, and in wires their average drift velocity is actually as slow as water in a sand-filled pipe. For example, the electricity that enters your home travels through the copper wire at an average rate of only $\frac{1}{2}$ -in. per second. The question is often asked: "Do the electrons in a direct-current circuit actually travel through the wire and back to the generator?" The answer is: "Yes, but it takes them a long time to make the circuit."

It is surprising that so slow a current, of such tiny particles as electrons, can produce such powerful effects. The secret, of course, is in numbers. The number of free or moving electrons in one cubic inch of a copper wire is, in figures, 15 followed by 23 ciphers; in terms of a drop of water it is about one-half of the number of drops in the Atlantic Ocean; and the number of electrons which flow through the filament of a 50 watt lamp in one minute is equal to the number of drops of water flowing over Niagara Falls in a century! These large numbers are difficult to conceive, but the difficulty is really in our minds, as the philosopher would tell us. For things seem big or small to us according to our standard of comparison. Physicists measure large numbers in terms of powers of ten. Thus 15 followed by 23 ciphers is simply 15×10 raised to the 23rd power. The physicist remembers it by the number 23, which is quite easy. Similarly, engineers have a standard of electric current which they call an ampere. If we compare the current through our lamp with this standard it comes out only one-half of an ampere, which seems quite small. Our purpose is to picture the passage of electricity through wires, and to compare it with its passage through gases and through vacuum. We shall find this comparison easy if we take the wire as our basis, and remember the number of moving electrons per cubic inch in a copper wire as 15×13 powers of ten, and their average drift motion as roughly $\frac{1}{2}$ -in. per second.

Gases are normally non-conductors, because the electrons are so tightly held by the atoms that none of them are free. But they can be freed by strong electric forces, and then gases conduct in much the same manner as metals. The process of forcing an atom to set free one of its electrons is called ionization, and the bereft atom an ion. The electrons thus set free drift between the ions and carry the electric current, exactly as in wires. In fact, an ionized gas may be said to conduct like a dilute metal.

The difference between electric current in gases and in wires is, first, the diluteness. In gases the number of free electrons is much smaller than in metals, and their velocity much greater. For example, in an arc at atmospheric pressure, the number of free electrons is about 100,000 times less than in a metal, and the average velocity 10,000 times greater, namely about 100 ft. per second; in very low pressure arcs, the number of free electrons is a million-million times less than in a wire, and their drift velocity about 1,000 miles per second. Yet, in spite of this small number and high velocity, such low pressure arcs are fairly good conductors, capable of carrying large currents at practical voltages.

The second distinctive feature of gaseous conductors is that the ions are continually drifting to the walls of the envelope and there gaining back their lost electrons, thus becoming normal atoms; so that new ions must be continually produced. If the production of new ions is stopped, then after a short time all those that were present will have reached the walls, and the gas is again a non-conductor.

(Incidentally this property of gaseous conductors has been utilized in the Thyatron tube, which is so designed that the gas in it can be made conducting or non-conducting at will, by means of a grid. This tube has therefore the valuable property of being able to start and stop electric currents, thus acting as an "electronic switch" for controlling electric machines. [The Thyatron was described in the September, 1930, and May, 1931, issues of Radio-Craft.—Technical Editor.]

Electric currents in vacuum are very different from those in wires and gases. We may pass quickly over the problem of getting the electrons into the vacuum, since the problem is easily solved by heating the metal electrode until the electrons have sufficient energy to jump out, as water molecules jump out or evaporate from hot water.

The unique feature of vacuum conduction is that it is composed solely of electrons. There are neither ions to neutralize electron space charge, nor atoms to bump against. In arcs and in metals there are as many ions as electrons, so that the mixture is electrically neutral, and has no tendency to fly apart from electrical forces. In vacuum, however, only electrons are present, and mutual repulsion reigns. Every electron shuns every other. They fly across the vacuum in open formation, so far apart that they could be seen separately with the naked eye if they were visible. For example, the electrons at the anode, or plate, of the average radio tube are .002-in. apart, which is several times the diameter of the filament in standard tungsten lamps. The number of electrons in the space is a thousand times smaller than in low pressure arcs, so small that it really does limit the current, even at electron speed of 10,000 miles per second.

This very mutual space-charge-limiting feature, as it is called, which limits the current-carrying capacity of the vacuum tube, is the secret of its power. For it makes the current controllable, completely and instantaneously, by the voltage of a grid. This is the principle of the "standard," or high-vacuum radio tube with which everyone is familiar.

We thus have three fundamental types of electric current conduction: metal wires, for our transmission lines and motors; gases, which can be made conducting or non-conducting at will and are destined to be the controllers of electrical machinery; and pure electron tubes, the devices that have made radio, talkies, and television possible—and beyond that—who knows what?

*Assistant Director of Research Laboratory, General Electric Co.

With

TRIAD



This corps of engineers, in their own secluded laboratory keep TRIAD tubes ahead of the procession. They are provided with the most modern laboratory apparatus and make periodical checks of every operation on every one of the many types TRIAD produces.

YOU GET

QUALITY

FROM A to Z



**TRIAD
QUALITY**

**IS A FACT--NOT MERELY
A CLAIM**

The easiest way to get a true estimate of any product's worth is to ask about it among its competitors. Ask any serviceman, dealer, jobber or manufacturer if any tubes are better than TRIAD QUALITY TUBES. We know the answers you get will induce you to send in the coupon, which will bring you the whole, interesting story.



Elaborate testing equipment developed by TRIAD engineers is found at the end of every production line. QUALITY is the watchword, QUALITY is demanded and an increasing number of satisfied users prove that TRIAD and QUALITY are synonymous.

PRICE LIST ON STANDARD TYPES RADIO TUBES

T-1	Mercury Half Wave Rectifier.....	\$ 2.60
T-01A	General Purpose Detector and Amplifier.....	.80
T-10	Power Amplifier.....	5.00
T-10S	High Voltage Power Amplifier.....	6.00
T-12A	D. C. Power Amplifier.....	1.30
T-22	D. C. Screen Grid Amplifier.....	2.00
T-24A	A. C. Screen Grid Amplifier.....	1.40
T-26	A. C. General Purpose Amplifier.....	.85
T-27	Detector or Amplifier having A. C. Heater.....	1.05
T-30	D. C. General Purpose Amplifier.....	1.30
T-31	D. C. Power Amplifier.....	1.30
T-32	D. C. Screen Grid Amplifier.....	1.90
T-33	D. C. Pentode Power Amplifier.....	2.10
T-34	D. C. Multi-Mu R. F. Amplifier.....	2.15
T-35	A. C. Heater Type Multi-Mu R. F. Amplifier.....	1.50
T-36	D. C. Screen Grid Amplifier; Heater Type.....	1.80
T-37	D. C. General Purpose Amplifier.....	1.40
T-38	D. C. Pentode Power Amplifier. Heater Type.....	1.60
T-39	D. C. Heater Type Multi-Mu R. F. Amplifier.....	1.80
T-40	D. C. Voltage Amplifier.....	2.00
T-41	Power Amplifier Pentode.....	1.60
T-45	A. C. Triode Power Amplifier.....	1.15
T-46	A. C. Power Amplifier.....	1.55
T-47	A. C. Pentode Power Amplifier.....	1.50
T-48	Power Amplifier Tetrode (30 volt DC Heater).....	3.00
T-50	A. C. Power Amplifier.....	4.00
T-51	A. C. Heater Type Multi-Mu R. F. Amplifier.....	1.50
T-55	A. C. Duplex Diode Triode.....	1.60
T-56	General Purpose Amplifier.....	1.20
T-57	A. C. Pentode R. F. Amplifier.....	1.65
T-58	A. C. Pentode Multi-Mu R. F. Amplifier.....	1.65
T-59	Heater Type Power Amplifier, Triple Purpose.....	2.00
T-864	D. C. General Purpose Amplifier.....	2.10
T-71A	A. C. or D. C. Power Amplifier.....	.95
T-85	D. C. Duplex Diode Triode.....	1.60
T-89	Triple Grid Power Amplifier.....	1.80
T-99X	Dry Battery General Purpose Amplifier.....	1.50
T-99V	Dry Battery General Purpose Amplifier.....	2.25
T-841	Power Amplifier.....	10.40
T-842	Heavy Duty Power Amplifier or Modulator.....	10.40
T-66	Half Wave Mercury Rectifier.....	6.75
T-80	Full Wave Rectifier.....	.90
T-81	Half Wave Rectifier.....	3.50
T-82	Full Wave Mercury Vapor Rectifier.....	1.20
T-83	Heavy Duty Full Wave Mercury Rectifier.....	1.55
T-TEL	Television Scanning.....	} Price on Application
T-CNA	Television Projection.....	
T-PEC	Photo-Electric Cell.....	
T-205D	Sound Movie Power Amplifier.....	7.75

"HONOR



"BUILT"

TRIAD MFG. CO.,
Pawtucket, R. I.

Gentlemen:—

Please send me full information
about TRIAD QUALITY tubes.

TRIAD MANUFACTURING CO.

PAWTUCKET, R. I.

"Four Radios in One"

The NEW Lincoln

— Lt. Comdr. R. H. G. Mathews, USNR

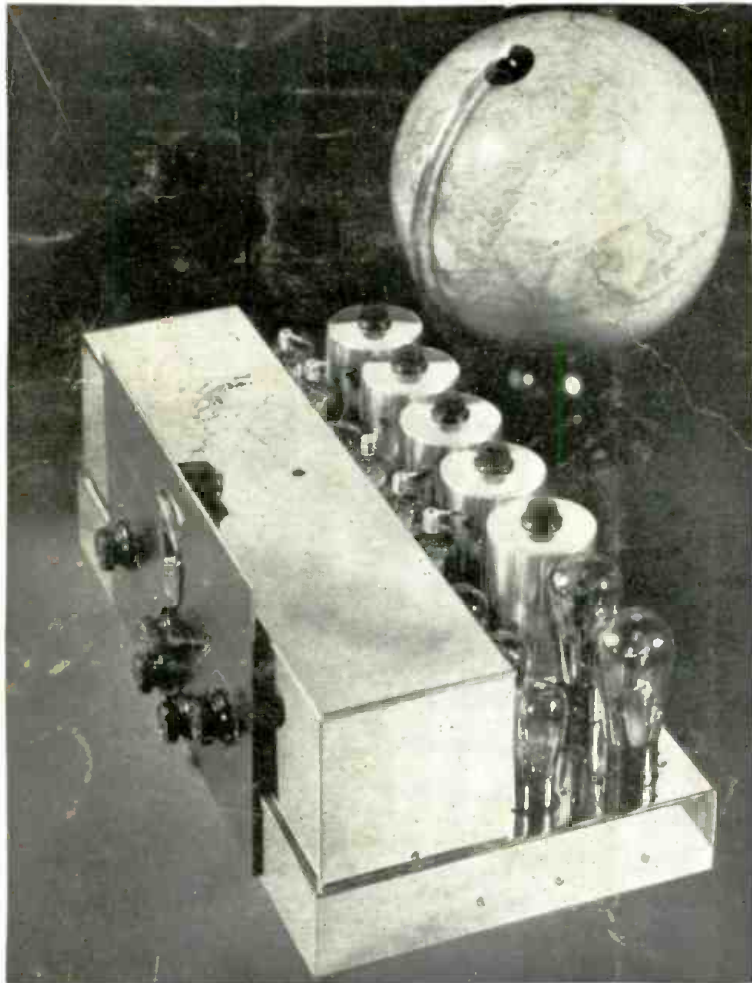

"I have always had a number of receivers for my own amusement—each built for a specific purpose. A set especially for CW, one for foreign short-wave reception, a set with nothing but tone, and a 'hot' selective super for DX broadcast reception. It is generally believed among radio engineers that you can't have them all in one receiver . . . I subscribed to this belief until I played with one of the NEW Lincolns. I was surprised to find, in this one set, all the advantages of my four specialized receivers . . ."

The above is taken from a letter from Lt. Comdr. R. H. G. Mathews, famed radio engineer, builder of broadcast stations, short-wave stations, former internationally renowned amateur and commercial operator, and, until recently, Commander of the Communication Division of the United States Naval Reserve in the 9th District.



And Lieutenant Commander Mathews' enthusiasm for the NEW Lincoln will not half equal yours when you feel its smooth ease of operation, discover for the first time how amazingly simple foreign broadcast reception really can be, check its almost limitless sensitivity, and listen to its powerful reproduction of the full musical scale. Write or send the coupon NOW for full details.

Sign coupon for prices, logs of foreign stations, etc.

LINCOLN RADIO CORPORATION
335 S. Wood St., Chicago, U.S.A.
Please send me FREE technical description of the New Lincoln.

Name _____
Street _____
City _____ State _____

LINCOLN

De Luxe Receivers